

PIONEER

THREE ROOM - DELUXE HEAT TRANSFER DUCT

Please ensure these instructions are read thoroughly before commencing installation and that all documentation is left with the home owner on completion of installation

WARNING

- Please read all instructions carefully before commencing installation.
- This appliance is not intended for use by persons (including children) with reduced physical, sensory or mental capabilities, or lack of experience and knowledge, unless they have been given supervision or instruction concerning use of the appliance by a person responsible for their safety.
- Children should be supervised to ensure that they do not play with the appliance.
- Precautions must be taken to avoid the back-flow of gases into the room from the open flue of gas or other open-fire appliances when mounted in outside walls or soffits.
- Isolate the mains supply before making any electrical connections. This system should be installed by a qualified electrician.
- All wiring must comply with national wiring rules
- A means of mains power isolation must be installed in the circuit for the purpose of safe access for any internal cleaning, recalibration or maintenance.
- All electrical, electronic and mechanical parts must be installed and all ducting secured before applying mains power.
- There are no isolated (safety extra low voltage) terminals incorporated. Please treat all terminals as being mains live.

KIT CONTENTS

Product Code	FAN0976
200mm Cone Inlet	1
200mm Three Speed Mixed Flow Fan	1
150mm x 3m Insulated Ducting	3
200mm x 3m Insulated Ducting	2
Thermostat / Fan Speed Controller V2.0	1
150mm Adjustable Cone Outlet	3
200-150-150-150 Double Branch Take Off	1
5m Duct Tape	1
Flush Box	1

HINTS

- Before making any holes in ceilings, check for access behind the ceiling, taking care to avoid ceiling joists, etc.
- Check the distance you want to run the duct as the shorter the duct run, the more efficient the fan will operate.
- **Remember! The hot layer of air is dispersed across the whole ceiling so it is not necessary to install the cone inlet directly near the fire flue. The cone inlet should be at least 2m away from the flue in order to avoid excessively high temperatures.**
- This Pioneer heat transfer duct can be extended a further 6 metres to a total duct length of 24 metres in the system. Additional duct should be fitted after the fan.
- The cone inlet should be located **as close as possible to the cone outlets** and at least 2 metres away from being directly above the wood fire.
- Although the fan is ball bearing mounted and very quiet, it is recommended to mount the fan on a solid surface such as the top plate of a wall partition or, even better, suspended in strops from the rafters, as this will ensure the quietest operation and eliminate any resonance. Strops are not supplied due to the variety of possible installation requirements, a strong 4mm – 6mm rope or cord is suitable as a strop material.
- Straight runs of ducting without tight bends are most efficient with the inner duct stretched reasonably tight to assist efficient airflow. If longer runs of ducting are necessary, ducting extensions with duct connector sleeves should be used.

THREE ROOM - DELUXE HEAT TRANSFER DUCT

INSTALLATION

1. CONE INLETS

Choose the inlet location within the heat source room and cut a hole for the cone inlet, using the cardboard template supplied. CARE MUST BE TAKEN TO CUT AN ACCURATE AND NEAT HOLE. Before fitting the cone inlet make sure the spring loaded arms are pushed upwards, as this will enable the arms to spring outwards when the cone inlet is inserted in to the cavity.

2. CONE OUTLETS

Choose the cone outlet location in the rooms to be heated. Cut the holes for each cone outlet, using the cardboard template supplied. Before fitting the cone outlet make sure the spring loaded arms are pushed upwards, as this will enable the arms to spring outwards when the cone outlet is inserted in to the cavity.

3. DUCTING

Fitting of ducting: Straight runs without tight bends are most efficient. The inner duct should be stretched reasonably tight to assist efficient airflow. When connecting insulated duct to the spigots, you first secure the *CORE* to the spigot with duct tape. Then pull the *INSULATION* up to the joint and tape the *OUTER SLEEVE* to the spigot with the duct tape. Stretch insulation over maximum amount of each joint to avoid heat loss.

- Fit one of the Ø200mm ducts between the cone inlet and the fan module.
- Fit the second Ø200mm duct between the fan module and the 200mm inlet of the duct splitter.
- Fit the three Ø150mm ducts between the 150mm outlets of the duct splitter and the 150mm cone outlets.

4. FAN MODULE

Locate the best mounting place for the fan unit in the ceiling space. Ensure the correct airflow direction is maintained when mounting the fan. Following location of suitable hanging points for the fan, locate the fan below its final resting place, and secure the duct. Make the wiring connections. It is recommended all wiring be performed by or in conjunction with a registered electrical contractor. Remember to allow sufficient cable to allow for the fan to be elevated off the ceiling joists. The fan should now be suspended approximately 400mm above the ceiling joists. **Note:** A suitable junction box will be required to connect the fan and mains supply.

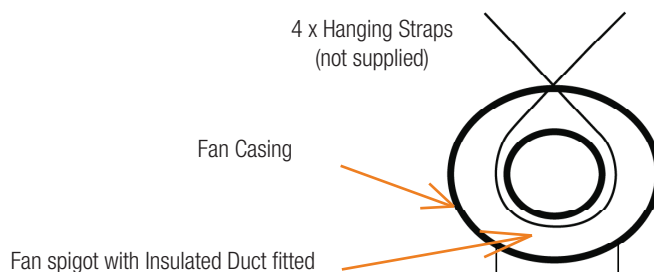

5. OPERATION

Once installed the Pioneer Heat Transfer Duct has several adjustments, which enable you to fine-tune the system to suit your home;

Cone outlets have adjustable centre cones enabling the airflow to be individually regulated for each room. To adjust the cone outlets turn the cone clockwise to decrease the airflow or anticlockwise to increase the airflow.

Thermostat is adjustable enabling you to set the temperature at which the system automatically turns on. Set the thermostat to the desired temperature (20°C is a good starting point) and once the temperature is exceeded, all excess heat will be distributed to other parts of your home while maintaining the pre-set 20°C in the room with the thermostat fitted.

IMPORTANT: You will need to set up the controller before use. Please refer to *Automated Thermostat Installation (page 4)*.

Note: This system does not generate heat, however, all measures have been taken to ensure that heat is not lost through this heat transfer system. The excess heat capacity available for transfer in the source room must exceed the overall heat losses in the target room if the temperature is to rise. The following points are worthy of consideration for you to optimise the performance of your system:

- | | | |
|---|---|--|
| <input type="checkbox"/> Do you have enough excess heat? | → | You may need to run your heat source at higher output levels! |
| <input type="checkbox"/> Is your property well insulated? | → | Heat lost through poor insulation costs you money! |
| <input type="checkbox"/> Background heating takes time? | → | Give the system time to create warm air circulation through the house. This may take several hours to establish! |

PIONEER

THREE ROOM - DELUXE HEAT TRANSFER DUCT

ACCESSORIES

150mm x 3m Insulated Ducting, Connector, Duct Tape	550-0600
200mm x 3m Insulated Ducting, Connector, Duct Tape	550-0620
Fourth Room Option Kit	550-0580

THREE ROOM - DELUXE HEAT TRANSFER DUCT

AUTOMATED THERMOSTAT INSTALLATION

1. Select the controller installation location.
 - The touch screen controller must be installed in the same room as the heat source.
 - Mount at least 1.5 metres above the floor on an internal wall preferably on a wall opposite the heat source.
 - Select the wall for ease of wiring to the fan.
 - Avoid locations which are not generally affected by changes in the room temperature.
 - Do not mount on hot surfaces or mount where exposed to direct sunlight.
2. Mounting Instructions and Installation
 - Cut an opening in the wall for flush box and mount it.
 - Run the electrical cable from the roof cavity down to the flush box.
 - Wire the cable to the back power module of the TSC and wire as per the wiring diagram below.
 - Separate the front screen of the TSC from the back module by carefully inserting a flat head screwdriver into the slot and gently levering the handle upwards.
 - Mount the power module to the flush box using the screws provided.
 - **CAUTION:** Using incorrect screws, or not tightening screws sufficiently, may cause damage to the product when re-assembling.
 - Ensure the circuit board on the back module is centred so the connections between it and the front screen can line up.
 - **CAUTION:** Forcing the controller back together without correctly aligning connections will damage the product.
 - Carefully attach the front screen to the back power module. Align the top edge then rock in and listen for a click.

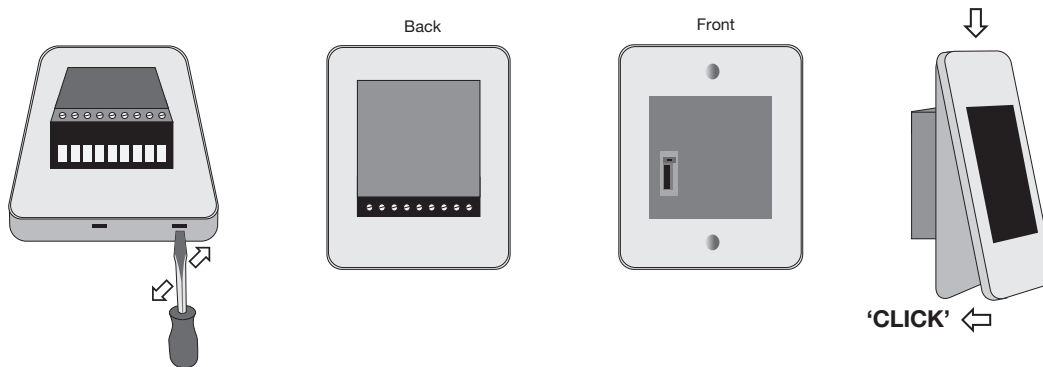

WIRING DIAGRAMS

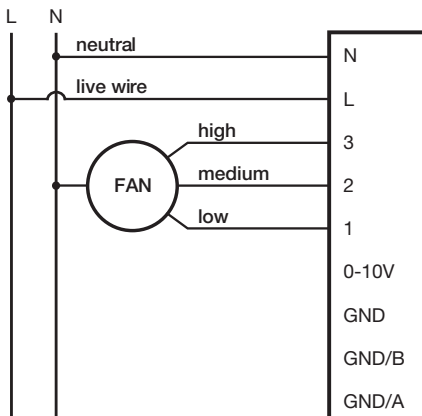

THREE ROOM - DELUXE HEAT TRANSFER DUCT

HOME SCREEN ICONS

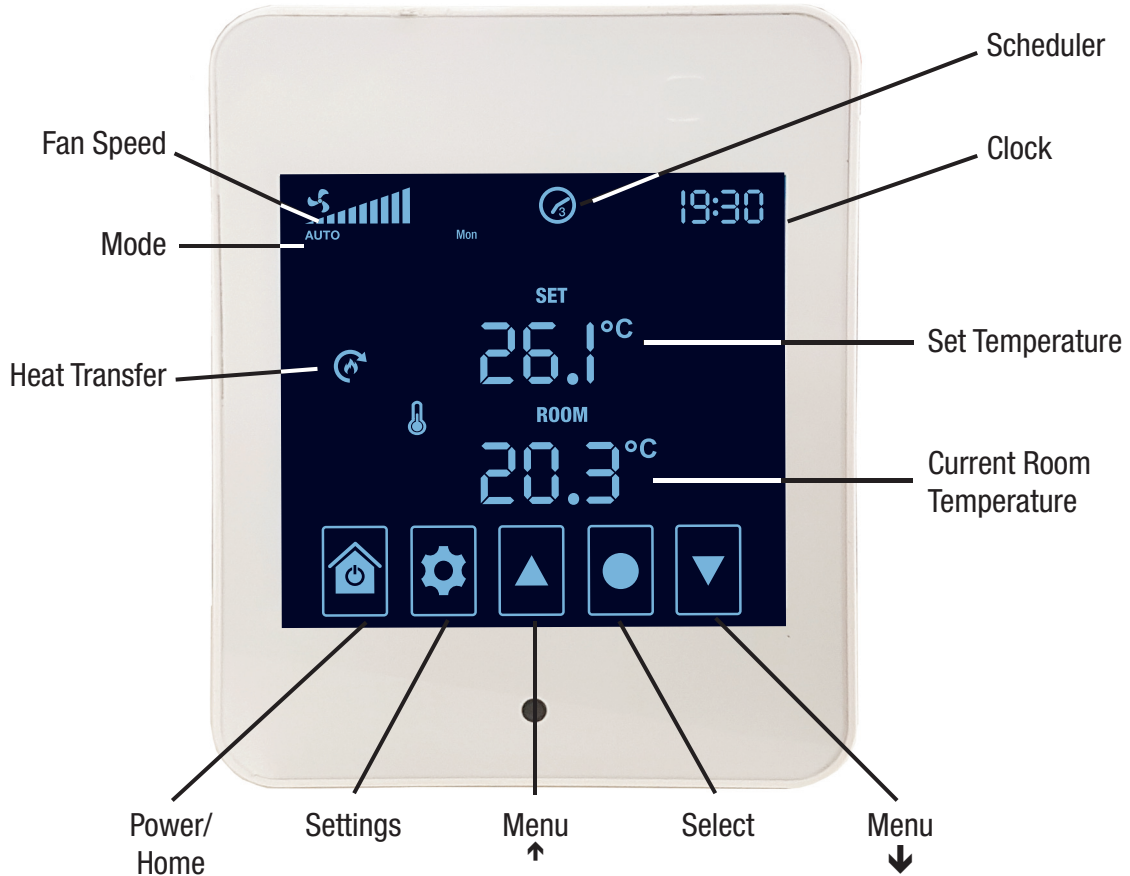

SETTINGS

For further control options, go to Home Screen and press SETTINGS . You can navigate this menu by pressing UP , DOWN and SELECT .

Button Functions in Setting Screens



Discard settings and go back to previous screen



Go back to previous parameter



Go to next parameter. Save changes when pressed on the final parameter



Navigate settings and adjust parameter value

QUICK ACCESS KEYS

Thermostats are programmed with easy access keys to auto and manual functions which are particularly helpful if the controller is operating in Scheduler Mode.

- Toggle between auto and manual modes by pressing SELECT .
- When in manual mode adjust fan speed by pressing UP and DOWN .
- When in auto mode adjust set temperature by pressing UP and DOWN .

THREE ROOM - DELUXE HEAT TRANSFER DUCT

SETTINGS MAP

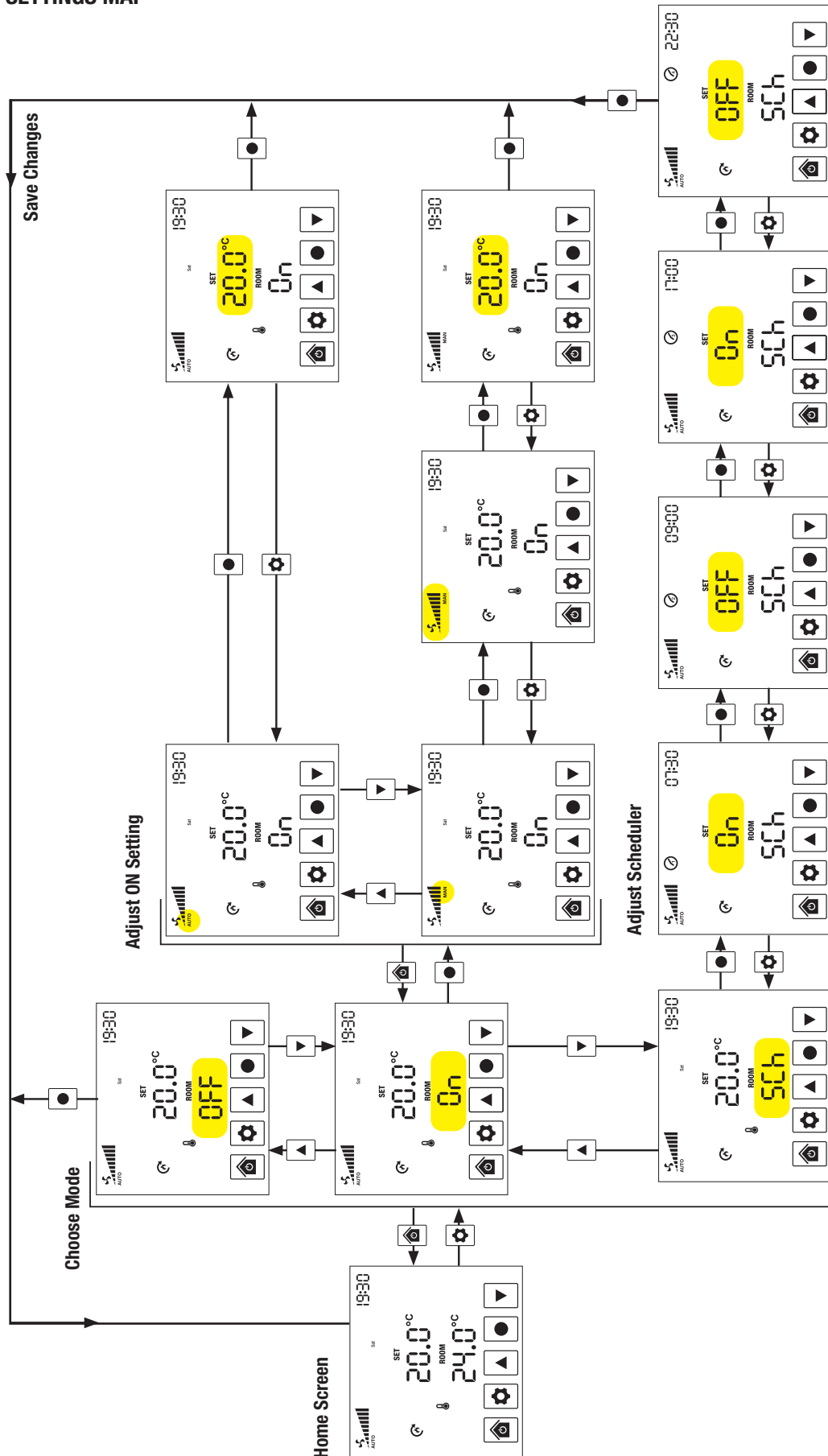

- 1 From the Home Page press **SETTINGS** to go to mode settings selection.
- 2 Press **UP** or **DOWN** to choose the mode settings you want to change.
- 3 Press **SELECT** to enter into the OFF, ON or SCHEDULER mode settings.
- 4 Use **UP** and **DOWN** to change the settings.
- 5 Press **SELECT** again to move onto the next setting of the chosen mode.
- 6 Press **SELECT** on final mode setting to save the changes and return to the Home Page.
- 7 Press **SETTINGS** to go back to the previous setting.
- 8 Press **HOME** to discard changes and return to the Home Page.

PIONEER

THREE ROOM - DELUXE HEAT TRANSFER DUCT

MODES

OFF Mode Fan will never turn on.

ON Mode The fan will turn on when the **ROOM** temperature reaches, or goes above, your **SET** temperature. Choose between **AUTO** (Automatic) or **MAN** (Manual) fan speed.

AUTO the fan speed automatically increases as your **ROOM** temperature gets warmer.

MAN the fan will turn on at your set speed.



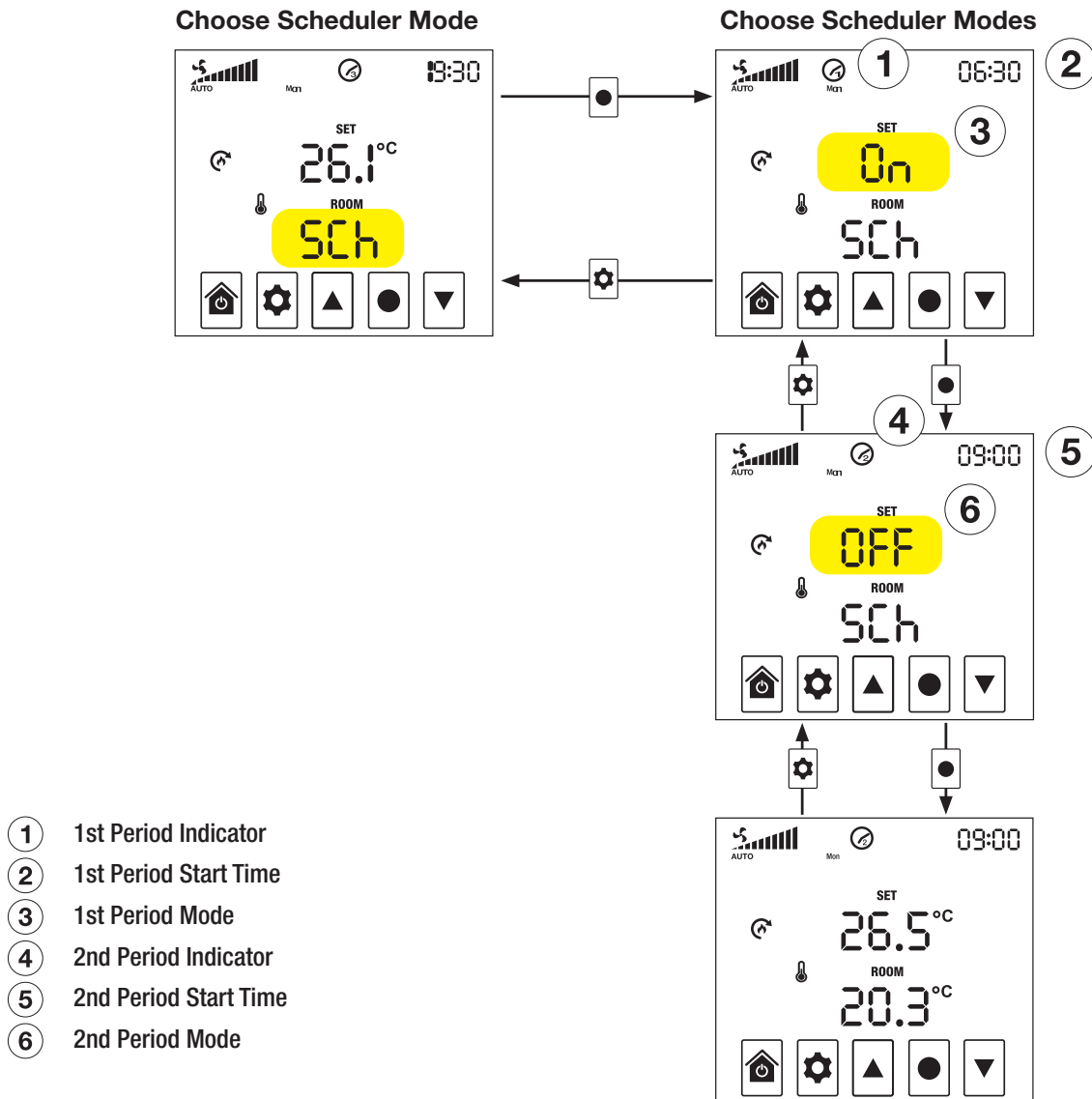

SCH Mode Schedule when your system will be in **OFF** mode or **ON** mode. Four adjustable time periods are available. Your set mode will start at the indicated period start timer and end at the next period start time. The fourth period start time will end at the first period start time on the next day.

Tip: Set up your desired **ON** mode settings first before setting up the **SCH** mode settings.



THREE ROOM - DELUXE HEAT TRANSFER DUCT

TIME-DATE SETTING

Hold SETTINGS  firmly for 3 seconds to enter into Time Date Settings. Press UP  and DOWN  to change settings and press SELECT  to step through settings.

HOME PAGE

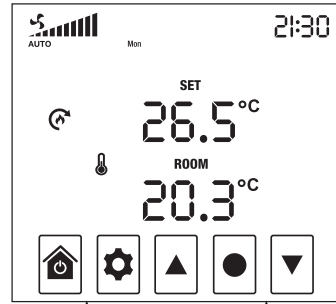
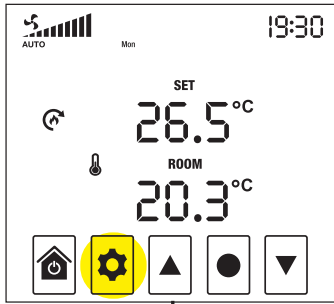

Hour



Date

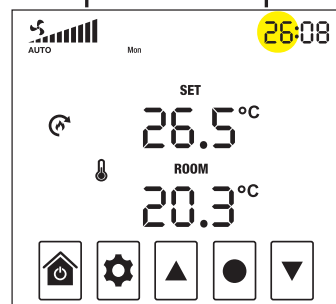

Minute



Month

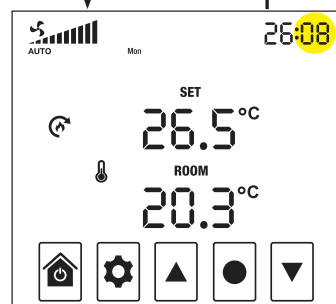

Day



Year

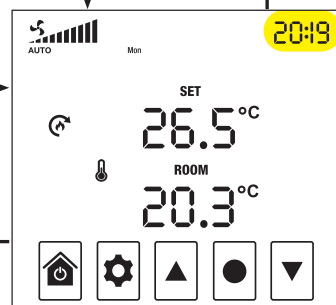

Discard Changes  Save Changes 

THREE ROOM - DELUXE HEAT TRANSFER DUCT

SCHEDULER TIME SETTING

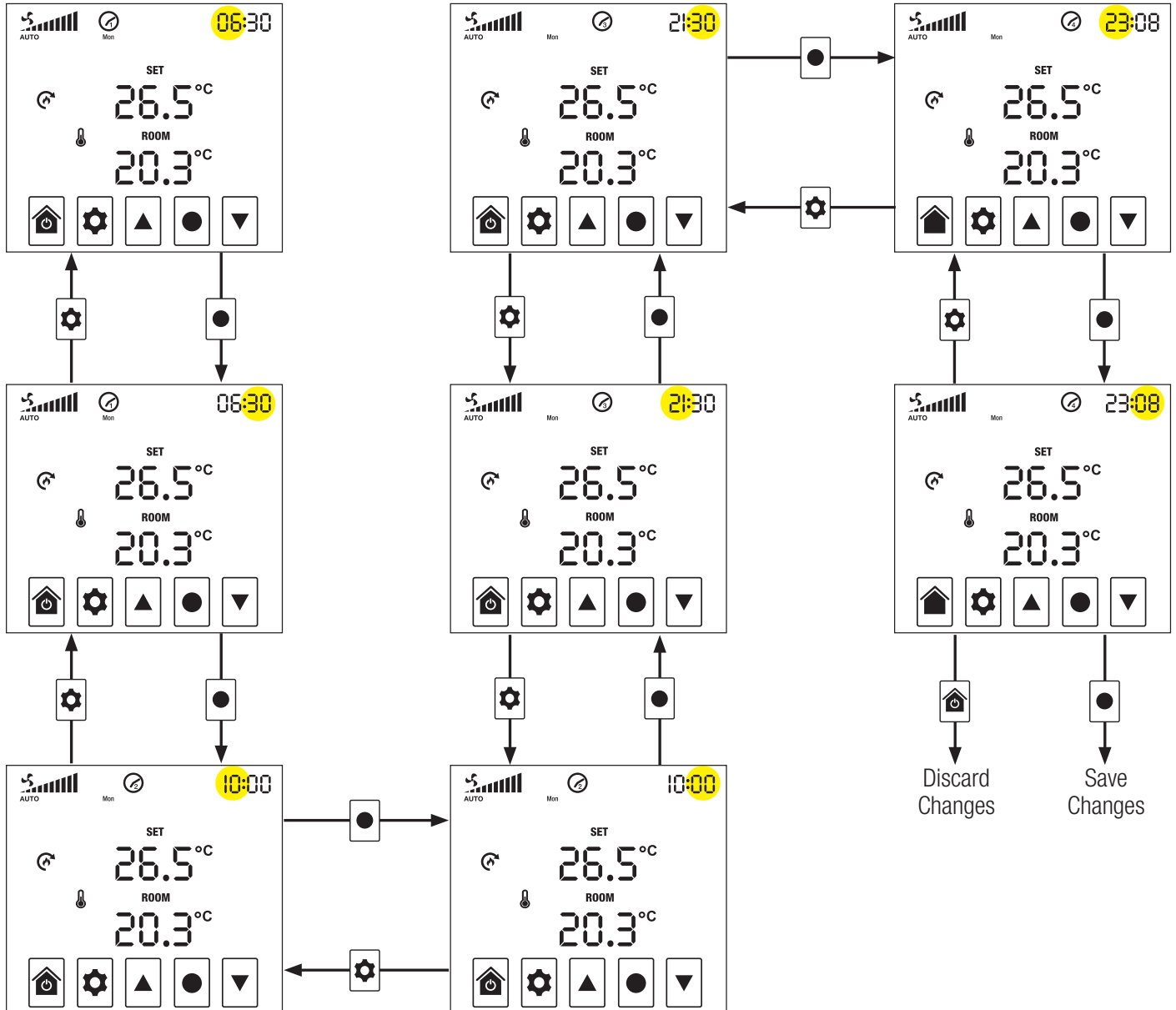

Enter the Time-Date Settings and navigate through the setup or press HOME  to enter into Scheduler Time settings. Press UP  and DOWN  to change settings and press SELECT  to step through the four schedule periods.

From TIME-DATE Settings









THREE ROOM - DELUXE HEAT TRANSFER DUCT

BOOST MODE

- On the Home Page, hold down SELECT  for 3 seconds and the system's fan will boost to Max speed.
- In BOOST mode, the time segments will become a count down to the end of BOOST mode.
- A quick tap of SELECT  on the Home Page will exit BOOST mode.

ADVANCED SETTINGS

- Turn the system off, then press and hold the space where SETTINGS  would usually be for, 3 seconds, to enter into Advanced Settings.
- Navigate through the Setting Number options with UP  and DOWN .
- Press SELECT  to save the Setting Number required and to enter into the selection of a Setting Value.
- Navigate through the Setting Value options with UP  and DOWN .
- Press SELECT  to save the Setting Value required.

Refer to *ADVANCED SETTING DETAILS* for setting descriptions.

Advanced Settings

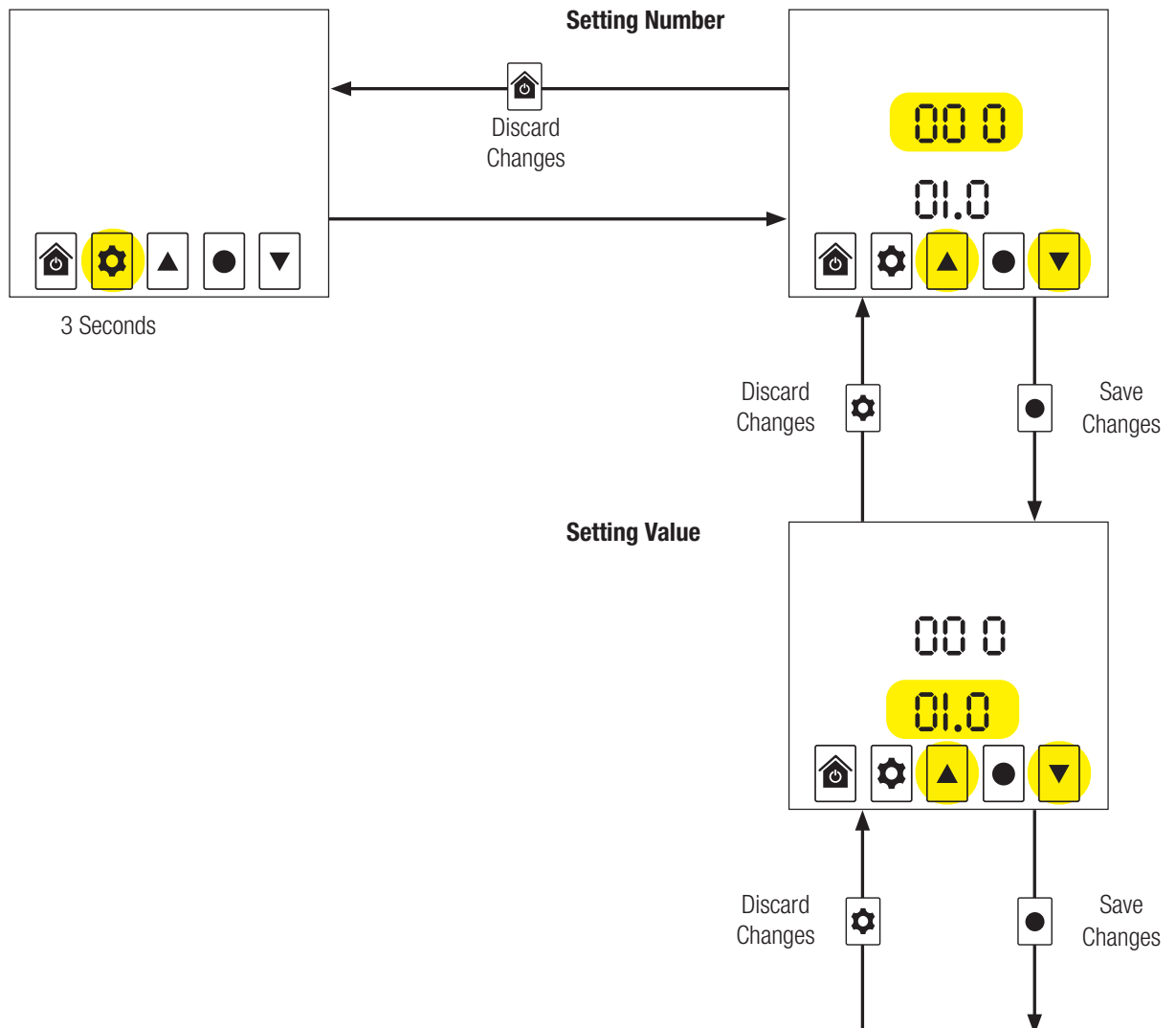

THREE ROOM - DELUXE HEAT TRANSFER DUCT

ADVANCED SETTING DETAILS

SETTING	DESCRIPTION	RANGE	DEFAULT	NOTE
000	Hardware Version Number	N/A	2.0	
001	Firmware Version Number	N/A	2.0	
002	Room Temperature Offset	-9°C - 9°C	-1.5°C	
003	Room Temperature Offset	-5°C - 5°C	1.0°C	
004	Screen Brightness - Maximum	0°C - 100°C	80%	
005	Screen Brightness - Minimum	0°C - 100°C	20%	
006	Boost Timer Time	0 min – 60 min	20 min	
007	Recycle Enable	0 - 1	1	
008	Recycle Speed	0 - 100%	0%	
009	Recycle Temperature - Maximum	20°C - 50°C	30°C	
010	Recycle Temperature - Minimum	0 - Recycle Max. Temp	5°C	
011	Temperature Set Times Hold	0°C - 5°C	1.5°C	
012	Temperature Set Differential	-5°C - 20°C	5°C	
013	Heat Transfer Speed Threshold - High	0°C - 10°C	5.0°C	
014	Heat Transfer Speed Threshold - Low	0°C - 10°C	2.0°C	
015	Filter Percentage	N/A	0	
016	Filter Reset	N/A	0	
017	Restore User Settings ☆	0 - 1	0	1 = restore
018	Installer Password	N/A	0	
019	Reserved	N/A	0	Do not change!
020	Reserved	N/A	1	Do not change!
021	Reserved	N/A	0	Do not change!
022	Reserved	N/A	0	Do not change!
023	Reserved	N/A	0	Do not change!
024	Fan Type	0 - 1	0	
025	Number of Fan Speeds	1 - 3	3	
026	Reserved	N/A	0	Do not change!
027	Key Sensitivity - Power	15 - 125	43	CAUTION*
028	Key Sensitivity - Setting	15 - 125	42	CAUTION*
029	Key Sensitivity - Up	15 - 125	45	CAUTION*
030	Key Sensitivity - Select	15 - 125	45	CAUTION*
031	Key Sensitivity - Down	15 - 125	45	CAUTION*
032	EC Fan Speed Setting - Low	0 - 100%	30%	
033	EC Fan Speed Setting - Medium	0 - 100%	50%	
034	EC Fan Speed Setting - High	0 - 100%	80%	
035	EC Fan Speed Setting - Boost	0 - 100%	100%	

* **CAUTION:** It is possible to render buttons inoperable and irrecoverable by adjusting the values. Adjust at your own risk.
The lower the value the more sensitive the button, the higher the value the less sensitive the button.

☆ Restores parameters 000-017 to default settings

PIONEER

THREE ROOM - DELUXE HEAT TRANSFER DUCT

SPECIFICATIONS

FAN		
Fan Type	3-Speed Mixed Flow	
Electrical Supply	220/240V AC 50 Hz	
Maximum Wattage	85W	
Maximum Pressure	250 Pa	
Airflow (free air delivery)	Low Speed	200 l/s, 720m ³ /hr
	Medium Speed	227 l/s, 820m ³ /hr
	High Speed	252 l/s, 910m ³ /hr
Sound Level	48 dB(A)	
Maximum Operating Temperature	45°C	
Compliance	AS/NZS60335.2.80:2016	

AUTOMATED THERMOSTAT V2.0	
Temperature Range	5-35°C adjustable
Display Resolution	1°
Operating Voltage/Frequency	220-240 V AC, 50Hz
Switching Voltage	240V AC Max
Switching Current	3A max resistive load
Sensing Element	NTC thermistor
Operating Temperature	0 to 40°C
Operating Humidity	5-90% non condensing
Live Output Isolation	Relay
Output Control	Relay
Display	3.5" digital LCD touch screen
Approval	All relevant AS/NZS standards
EMC Approval	All relevant AS/NZS standards  E6337

PIONEER

MANUFACTURING LIMITED

Email: info@metrofires.co.nz | Web: www.metrofires.co.nz