



metròfires

INDOOR FIREPLACES

Warmth, comfort and reliability

Unlike non-renewable fossil fuels, wood fuel is a renewable energy source and when harvested from sustainable forestry, is a far better choice for the environment. Wood is a natural, carbon neutral fuel and when burnt efficiently and cleanly generates no more carbon dioxide (CO₂) than if it was left to naturally decompose. The CO₂ produced by burning wood fuel is re-absorbed by plants and trees and continually exchanged within the carbon cycle.

Metro Fires are a family owned and operated company with a long family history and we're proud to support local industry by designing and manufacturing our fires right here in New Zealand. We use the highest quality materials and workmanship with the latest manufacturing techniques to bring you New Zealand's largest range of wood fires and complementary heating accessories.

Make your home warmer, drier and healthier with the warmth, comfort and reliability of a New Zealand made Metro fire.



Contents

Where to start	3
Overview	4
Indoor fireplaces	
Tiny series	6
Wee series	8
Xtreme series	12
NightView series	14
Mega series	20
Insert and Built-In series	22
Outdoor fireplaces	
Outdoor 850	24
Outdoor 1200	26
Accessories	
ECO flue systems	28
Floor protectors	32
Heat transfer systems	36
Specifications	
Insert and Built-In specifications	38
Freestanding specifications	40

Why Metro?

Impressive warmth and performance

Metro fires are designed to heat up quickly and reach peak output within an hour of lighting. Results illustrated show a Metro Wee series firebox reaching its 15kW peak output within an hour of lighting.

Metro fires are tested by independent International Accredited New Zealand testing facilities (IANZ) and during testing each model achieves a peak heat output.

Heat output is detailed in kilowatts (kW) and is the maximum amount of heat that a fire is capable of producing during the burn cycle. Output varies for each model and is also dependent on the quality and amount of fuel used and how frequently the firebox is reloaded during operation.

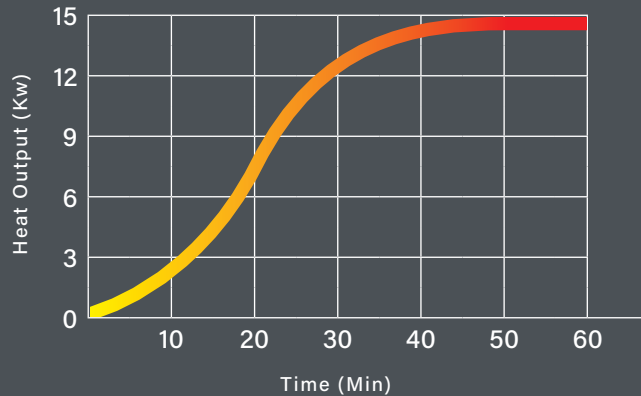

Extended burn times

Burn time indications are achieved using specific fuel with the firebox loaded to capacity and set to the lowest air setting. Low air settings reduce the speed of combustion and lower heat output. Lower air settings are required for extended burn times or once your home has reached a comfortable temperature. A high air setting draws more air into the firebox, enhancing combustion and generating more heat. A high air setting is required when first lighting your fire and for a short time when reloading fuel. Higher air settings may also be required in homes that are poorly insulated or located in a very cold climate.

 Ultra low emission models (local council specified airsheds)	4-6 hours low burn time
 Clean air approved models (properties under 2 hectares)	6-8 hours low burn time
 LTD rural models (lifestyle and rural properties 2 hectares+)	8+ hours low burn time

Advertised peak heat outputs (kW ratings) are based on the NZHHA Maximum Output test method which is undertaken by independent International Accredited New Zealand (IANZ) testing facilities.



Where to start

Installation and model options

Decide on the type of installation and confirm if your home is located within a clean air zone or specified airshed. This will determine the type of model you can install. In most parts of New Zealand, properties less than 2 hectares (just under 5 acres) require a clean air approved wood fire. Some regions have specific air sheds with more stringent regulations that require an Ultra low emission burner. If you're on a property of 2 hectares or larger, you can install any fire in the Metro range including the LTD models which deliver extended burn times.

Installation options	<input type="checkbox"/> Freestanding	<input type="checkbox"/> Insert	<input type="checkbox"/> Built-in
Flue options	<input type="checkbox"/> ECO flue kit	<input type="checkbox"/> ECO Insert kit	<input type="checkbox"/> ECO Built-In kit
Model options	<input type="checkbox"/> Clean air approved	<input type="checkbox"/> LTD rural (2Ha+)	<input type="checkbox"/> Ultra low emission

Heating area and output

The right size fire for your home and heating requirements with correct operation and good dry fuel, will provide you many years of warmth and reliable heating. As a guide, 1kW of heat output = 10m² of heating area. For example a 15kW fire would suit a standard 150m² 3 bedroom home. Heating area indications are based on a home with a 2.4m ceiling height in an average climate with insulation to current NZ standards.

Home size	<input type="checkbox"/> 2-3 bedrooms	<input type="checkbox"/> 3 bedrooms	<input type="checkbox"/> 4+ bedrooms			
Heating area	<input type="checkbox"/> 120m ²	<input type="checkbox"/> 140m ²	<input type="checkbox"/> 150m ²	<input type="checkbox"/> 160m ²	<input type="checkbox"/> 200m ²	<input type="checkbox"/> 250m ²
Heat output	<input type="checkbox"/> 11kW	<input type="checkbox"/> 14kW	<input type="checkbox"/> 15kW	<input type="checkbox"/> 16kW	<input type="checkbox"/> 18kW	<input type="checkbox"/> 21kW

Floor protectors and accessories

We have a wide range of floor protectors and accessories designed to complement your Metro fire. Our range of floor protectors (hearth) can be installed directly over any flooring substrate for quick and easy installation. Most Metro fires can also be fitted with a wetback to assist with your homes water heating and our heat transfer systems perfectly partner with your fire to spread warmth throughout your home. .

Floor protector	<input type="checkbox"/> Wall installation	<input type="checkbox"/> Corner installation	
Heating accessories	<input type="checkbox"/> Wetback (hot water)	<input type="checkbox"/> Heat transfer system	<input type="checkbox"/> Wood stack

Overview

Tiny series

11kW/14kW

















Heat up to 120m² - 140m² / 2-3 bedroom home

	Tiny Ped	11kW			Tiny Rad Woody	11kW	
	Tiny Rad	11kW			Ultra Tiny Rad	14kW	

Wee series

15kW

















Heat up to 150m² / 3 bedroom home

	Wee Rad Base	15kW			LTD Wee Rad Base	15kW	
	Wee Rad Leg	15kW			LTD Wee Rad Leg	15kW	
	Wee Rad Woody	15kW			LTD Wee Rad Woody	15kW	
	Wee Ped	15kW			Ultra Wee Rad	15kW	
	Wee Curve DV (Direct vent)	15kW					

Xtreme series

18kW

Heat up to 200m² / 4 bedroom home

	Xtreme Rad Base	18kW			LTD Xtreme Rad Base	18kW	
	Xtreme Rad Leg	18kW			LTD Xtreme Rad Leg	18kW	
	Xtreme Rad Woody	18kW			LTD Xtreme Rad Woody	18kW	
	Xtreme Ped	18kW			Ultra Xtreme Rad	18kW	

NightView series

15kW/16kW/18kW

Heat up to 150m² - 200m² / 3-4 bedroom home

	Ambie One	15kW			Ambie Plus	18kW	
	Rad Plus	16kW			LTD Rad Plus	16kW	

Mega series

21kW

Heat up to 250m² / 4-5 bedroom home

	Mega Rad	21kW			LTD Mega Rad	21kW	
---	----------	------	---	---	--------------	------	---

Insert series

15kW



Heat up to 150m² / 3 bedroom home

	Smart Insert	15kW			LTD Smart Insert	15kW	
	Trend Insert	15kW			Ultra Insert	15kW	

Built-In series

15kW/18kW

Heat up to 150m² - 200m² / 3-4 bedroom home

	Smart Built-In	15kW			LTD Smart Built-In	15kW	
	Trend Built-In	15kW			Ultra Built-In	15kW	
	Mega Smart Built-In	18kW					

Model options

-  Clean air approved model
-  LTD rural model (2 hectares+)
-  Ultra low emission model (ULEB)



Tiny series

11kW / 14kW

The Metro Tiny series offers a range of clean air approved low emission fires designed for smaller homes and open areas. These compact versatile fires feature surprisingly large volume fireboxes that punch well above their weight in winter heating performance.

Durable New Zealand steel fireboxes deliver both radiant and convection heating. Cook your favourite soup or boil the kettle on the flat cooktop of the radiant models. All models (excluding the Ultra Tiny Rad) can also be fitted with a wetback to assist with your homes water heating.

Tiny Ped



Tiny Rad



Tiny Rad Woody



Ultra Tiny Rad



Model	Tiny Ped / Tiny Rad / Tiny Rad Woody
Heating area	Heat up to 120m ² / 2-3 bedroom home
Heat output	11kW peak heat output
Finish	Metallic black high temperature paint
Wetback options	2kW wetback (Tiny Ped and Tiny Rad) Side wetback (Tiny Rad Woody)

Model	Ultra Tiny Rad
Heating area	Heat up to 140m ² / 3 bedroom home
Heat output	14kW peak heat output
Finish	Metallic black high temperature paint

 Clean air approved model

 Ultra low emission model (ULEB)



Wee series

15kW

The Metro Wee series offers a mix of clean air approved low emission fires with a selection of LTD models designed for rural and lifestyle properties with a land area of 2 hectares or larger. Choose from the popular leg model, pedestal base or wood stacker configurations.

Durable 6mm steel fireboxes deliver both radiant and convection heating. Enjoy the impressive radiant heat and flame views from the generous glass window. All models (excluding the Ultra Wee Rad) can also be fitted with a wetback to assist with your homes water heating.

Wee Rad - Base



Wee Rad - Leg



Wee Rad - Woody



Wee Ped





Ultra Wee Rad



Features

Heating area	Heat up to 150m ² / 3 bedroom home
Heat output	15kW peak heat output
Finish	Metallic black high temperature paint
Wetback options	Side wetback (Clean air approved models) 3kW or 4kW wetback (LTD rural models)

-  Clean air approved model
-  LTD rural model (2 hectares+)
-  Ultra low emission model (ULEB)

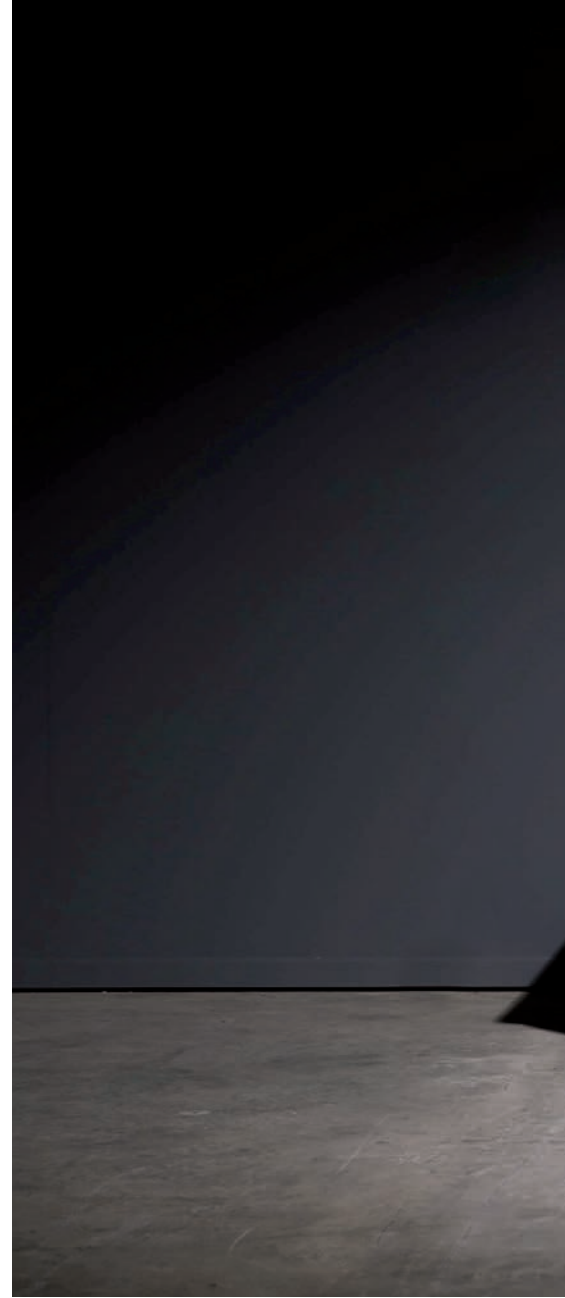

Wee Curve DV **15kW**

The Wee Curve DV features direct-vent capability and delivers an impressive 15kW of heat output to your home. Direct Vent technology allows combustion air to be pre-heated before entering the firebox, allowing for greater combustion temperatures, lower emissions and higher efficiencies. Flexible venting options offer outside air supply connection through a wall, floor or ceiling vent kit.

Euro styling with a smooth radiused ashlip, cooktop and panoramic curved glass window ensuring the perfect flame view from any angle. The radiant cooktop offers ample space for a pot or kettle.

Features

Heating area	Heat up to 150m ² / 3 bedroom home
Heat output	15kW peak heat output
Finish	Metallic black high temperature paint
Direct vent	Wall, floor and ceiling venting kits available

 **Clean air approved model**

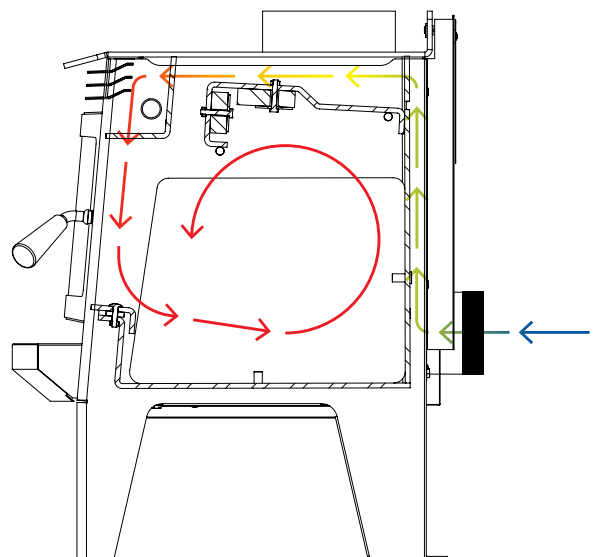



Direct vent kit - Wall

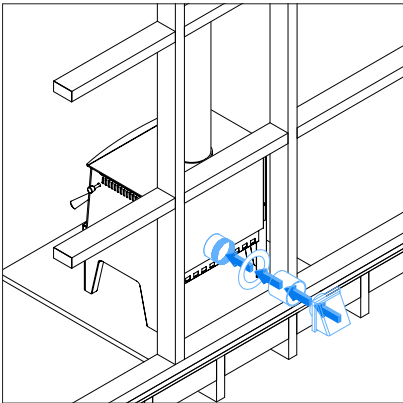

Direct vent through a wall cavity to outside the home.

Direct vent kit - Floor

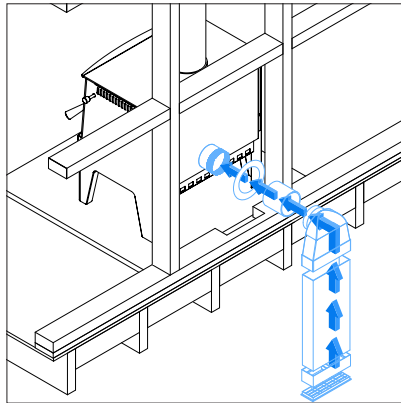

Direct vent into a wall cavity and down through the floor of the home.

Direct vent kit - Ceiling

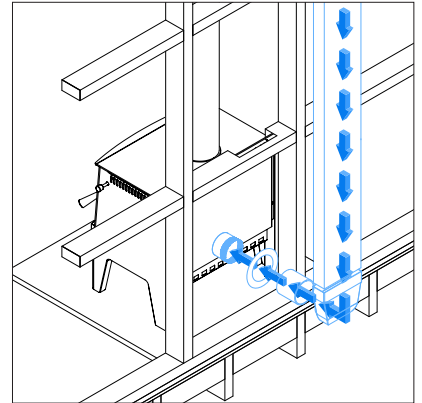

Direct vent into a wall cavity and up into the ceiling cavity of the home.



Xtreme series

18kW

The Metro Xtreme series offers a mix of clean air approved low emission fires with a selection of LTD models designed for rural and lifestyle properties with a land area of 2Ha or greater. Choose from the popular leg option, pedestal base or wood stacker configurations.

Large New Zealand steel fireboxes deliver both radiant and convection heating. Enjoy the impressive radiant heat and flame views from the generous glass window. All models (excluding the Ultra Xtreme Rad) can also be fitted with a wetback to assist with your homes water heating.

Xtreme Rad - Base



Xtreme Rad - Leg



Xtreme Rad - Woody



Xtreme Ped





Ultra Xtreme Rad



Features

Heating area	Heat up to 200m ² / 4 bedroom home
Heat output	18kW peak heat output
Finish	Metallic black high temperature paint
Wetback options	3kW wetback (clean air approved models) 3kW or 4kW wetback (LTD rural models)
Convection fan	Ultra Xtreme Rad model only

-  Clean air approved model
-  LTD rural model (2 hectares+)
-  Ultra low emission model (ULEB)

NightView



Innovative fire viewing glass

Metro's Ambience series and Rad Plus models feature the innovative black glass-ceramic ROBAX® NightView from SCHOTT. Fireplace glass which comes alive as soon as the fire is lit and begins to burn.

The tinted glass-ceramic ROBAX® NightView offers a completely new experience for wood fire owners. The viewing panel not only calms the flames, giving them a darker, more natural colour, but it also makes a feature of the fire, providing a focal point for the room that will draw the eye and hold attention.

When the fire is not in use, ROBAX® NightView underlines the fire's clean aesthetic by concealing the internal firebox from view.

ROBAX® NightView

ROBAX® NightView - High burn



The special fire-viewing panel comes alive as soon as the fire is lit and transforms the flame picture by softening the brightness and liveliness of the flames.

ROBAX® NightView - Low burn



When the flames and embers burn down during the burn cycle, ROBAX® NightView calms and darkens the flames to create a more comforting atmosphere.

ROBAX® NightView - Cold



When the fire is not in use, ROBAX® NightView underlines the beauty of the fireplace by concealing the combustion chamber and any soot or ash within.

Best.

Award winning design

New Zealand's Best Awards showcase the best of what kiwi designers and brands have to offer. The Ambience series received awards in both Consumer and Sustainability Product Design categories.



Ambience series

15kW / 18kW

Award winning design with exceptional performance and styling. Ambience models feature the innovative black glass-ceramic ROBAX® NightView which comes alive once the fire is lit and begins to burn.

From the initial spark to the final embers slowly burning out, the Ambience series is the embodiment of minimalist design and smooth styling. Get the best of both radiant and convection heat from these convection fires that also generate huge radiant heat through the one piece glass front.

Ambie One



Ambie Plus



Model	Ambie One	Ambie Plus
Heating area	Heat up to 150m ² / 3 bedroom home	Heat up to 200m ² / 4 bedroom home
Heat output	15kW peak heat output	18kW peak heat output
Finish	Metallic black high temperature paint	Metallic black high temperature paint
Door glass	ROBAX® NightView black ceramic glass	ROBAX® NightView black ceramic glass
Wetback options	3kW or 4kW wetback*	3kW wetback

*Wetback options are only available for the Ambie One when installed on a property with a land size of 2 hectares or larger.

Clean air approved model

Benchtop installation

The Ambience models can also be installed without the pedestal onto a custom-built base such as concrete, stone or other non-combustible material. Base construction must be with non-combustible materials and cannot sit directly on any heat sensitive material.

A plinth makes viewing your fire more accessible, easier when refuelling and cleaning, and provides a practical space beneath to neatly store your firewood.

Full installation details and specifications are available at metrofires.co.nz and included within the Ambience Series installation and operation manual. See your Metro retailer about the bench options available.





Rad Plus **16kW**

The Metro Rad Plus features the innovative black glass-ceramic ROBAX® NightView from SCHOTT. Contrasting nicely against the metallic black paint finish, the upright vertical design with minimalist detailing, brings a clean and refined aesthetic with a magnificent flame view. The unique firebox design delivers a super clean burn with incredibly low particulate discharge.

A base compartment offers convenient and practical storage with push-button door opening for easy access.

Features

Heating area	Heat up to 160m ² / 3 bedroom home
Heat output	16kW peak heat output
Finish	Metallic black high temperature paint
Door glass	ROBAX® NightView black ceramic glass
Wetback option	Side wetback (both models)

- Clean air approved model
- LTD rural model (2 hectares+)



Convenient storage



The base compartment offers convenient storage with push-button door opening for easy access.



ROBAX® NightView - High burn



The special fire-viewing panel comes alive as soon as the fire is lit and transforms the flame picture by softening the brightness and liveliness of the flames.

ROBAX® NightView - Low burn



When the flames and embers burn down during the burn cycle, ROBAX® NightView calms and darkens the flames to create a more comforting atmosphere.

ROBAX® NightView - Cold



When the fire is not in use, ROBAX® NightView underlines the beauty of the fireplace by concealing the combustion chamber and any soot or ash within.



Mega Rad 21kW

The largest fire in the Metro range. Available in both clean air approved low emission and LTD version suitable for rural and lifestyle properties with a land area of 2 hectares or larger.

The Mega Rad features a huge firebox with a 10mm steel cooktop. The firebox handles hefty firewood with ease and is capable of delivering up to 21kW's of heat output to keep the largest of homes warm and comfortable all winter long.

High output wetback options are available for both models.

Features

Heating area	Heat up to 250m ² / 4-5 bedroom home
Heat output	21kW peak heat output
Finish	Metallic black high temperature paint
Wetback options	3kW wetback (Clean air approved model) 3kW or 4kW wetback (LTD rural model)

- Clean air approved model
- LTD rural model (2 hectares+)



Water heating options

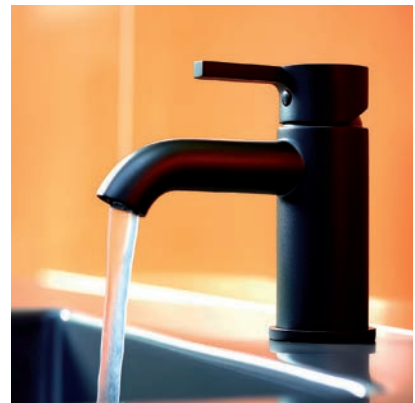

Winter warmth, wetback water heating and cooking capabilities are all dominant features of the Mega Rad models.



Panoramic fireside views



Enjoy watching the flames through the 600mm wide landscape door glass thanks to Metro's clever airwash technology.

Mega firebox capacity



The large volume firebox produces a peak heat output of 21kW and can be loaded with fire wood up to 480mm in length.

Solid steel 10mm cooktop



The solid steel 10mm cook top provides plenty of space for cooking a meal and boiling the kettle.



Insert and Built-In series

15kW / 18kW

Image: Smart Insert Built-In installation including optional fascia base rail.

Insert models are the perfect fit for replacing an inefficient open fireplace or older style insert fire. Designed for installation into an existing masonry chimney and installed with the Metro ECO Insert flue kit.

Insert models can also be installed with an appliance specific Vented Zero Clearance Cabinet (VZCC) and ECO Built-In flue kit for installation into a purpose-built timber framed cavity (false chimney).

The Mega Smart Built In is a dedicated 'Built-In' fire and has a VZCC pre-fitted to its firebox for direct installation into a timber framed cavity. All Built-In installations must be installed with the Metro ECO Built-In flue kit.

Trend Insert / Trend Built-In



Smart Insert / Smart Built-In



**Insert installation
(masonry chimney)**

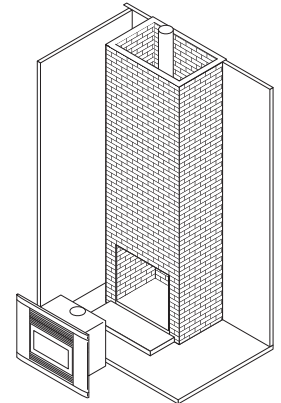

Ultra Insert / Ultra Built-In



Mega Smart Built-In



**Built-In installation
(timber framed cavity)**

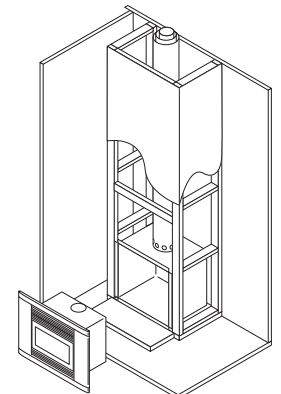

Model	Trend / Smart / Ultra Insert	Mega Smart Built-In
Heating area	Heat up to 150m ² / 3 bedroom home	Heat up to 200m ² / 4 bedroom home
Heat output	15kW peak heat output	18kW peak heat output
Convection fan	Trend Insert and Ultra Insert models	-
Finish	Metallic black high temperature paint	Metallic black high temperature paint
	Black vitreous enamel (Ultra Insert only)	-
Wetback options	3kW or 4kW wetback (Trend Insert)*	Mega Smart wetback
	Smart wetback (Smart Insert models)	

*Wetback options are only available for the Trend model when installed on a property with a land size of 2 hectares or larger.

 Clean air approved model

 LTD rural model (2 hectares+)

 Ultra low emission model (ULEB)

Outdoor 850



Pizza oven / Grill / Fireplace

Sear food to perfection on the cooking grill, slide in the pizza stone and watch the mozzarella melt, cook on top or simply sit back and enjoy the warmth and ambience.

All models include a cooking grill and pizza stone, pizza peel, grill lifter, ember rake and your choice of flue system.

The landscape window offers panoramic fireside views, safety during operation and the closed-door firebox creates the wood-fired oven cooking experience and prevents any wind blown ash and smoke nuisance often found with open fronted fires.

Solid Corten steel firebox construction and firebrick lined for heat retention and durability. All fastenings are stainless steel for high heat with high temperature satin black and zinc based coatings specially formulated for outdoor use.

Choose either a freestanding or roof penetration flue system to suit your installation. Roof penetration flue kits are available for covered outdoor areas.



Roof penetration flue options are available for covered outdoor areas



Get a copy of the Outdoor catalogue from your local Metro stockist or download at metrofires.co.nz

Outdoor 850-B (Base)



The 850-B is designed for installation onto a non-combustible plinth or benchtop to your desired design (base not included).

Outdoor 850-P (Pedestal)



The 850-P features a solid Corten steel pedestal base with a large foot for secure placement and stability.

Outdoor 850-T (Trolley)



The 850-T features a large volume trolley base for storage of firewood, cooking grill and pizza stone.

Outdoor 1200



Braai / Barbecue / Fireplace

The term Braai (pronounced bry') originates from the Afrikaans word braaivleis, meaning 'roasted or grilled meat.' Traditional braai's are cooked over embers and the type of wood used can make a big difference to the smokey flavours produced during cooking.

The Outdoor 1200 models are available as a 'fire only' option or the Braai option including the full Braai setup and cooking accessories. Fire only options include an ember tool and fire mitts but exclude all other Braai accessories.

Installation can be onto a suitable plinth base, the portable option with the trolley or a more permanent setting into a custom-built chimney enclosure.

All Braai cooking grills and accessories are easily removed from the firebox after cooking for use as a fire only. Entertain in style keeping your guests well fed, warm and comfortable as the evening air cools down.

Outdoor 1200



Installation onto a non combustible plinth or base to your desired design.

Outdoor 1200 Trolley



Complete with a powdercoated aluminium and stainless steel trolley base.

Outdoor 1200 Insert



Designed for installation into a non combustible masonry structure.

Model	Outdoor 1200 (Braai) / Outdoor 1200 (Fire only)
Installation options	Base / Trolley / Insert
Flue options	Freestanding flue system (Base and trolley installation) / Insert flue system (Insert installation)
Firebox	Solid Corten steel finished in zinc black paint
Door/cover	Removable stainless steel door/cover
Accessories	(Braai) Full Braai cooking setup and accessories as shown below (Fire only) Ember tool and Outdoor fire mitts only

* The concrete base illustrated is not included. Plinth, base and insert enclosure construction are all customer care. Model images shown above feature the full Braai cooking setup.

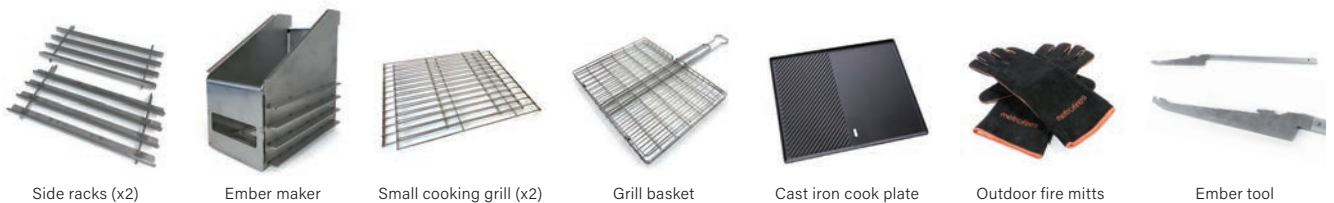

Side racks (x2)

Ember maker

Small cooking grill (x2)

Grill basket

Cast iron cook plate

Outdoor fire mitts

Ember tool

Metro ECO flue

Increase performance and efficiency

Maximise your fires performance by installing a Metro ECO flue kit. An ECO flue kit is an efficient way to get the best performance from your wood fire – heating your home faster and consuming less firewood in the process.

All flue systems require moving air between the liners to ensure the outer liners remain cool. A Metro ECO flue kit draws air from your homes ceiling cavity or from outside your home, unlike a Standard flue kit which draws air from the room being heated by your fire.

Independent lab testing of a Standard Flue Kit showed the warm air being drawn from the room at an astounding rate of 450 litres per minute.*

The warm air being lost is then replaced by cooler air drawn into the room at the same rate, from other parts of the home creating a constant incoming draught. This requires your fire to be operated at a higher burn rate using more firewood to continually heat the cooler incoming air.

Metro ECO flue kits are available with either galvanised or stainless steel outer casings (excluding the Insert flue kits). Stainless steel outer casings are recommended for all coastal installations and where a superior level of finish is required.

ECO flue installation options

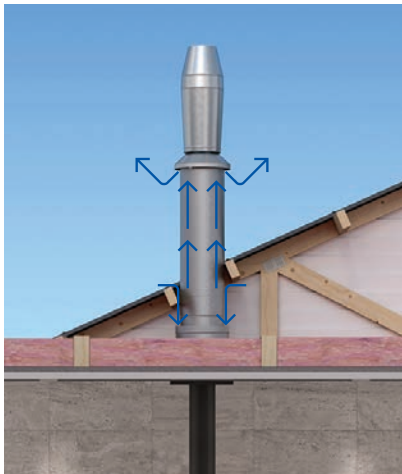

Flat ceiling with ceiling cavity

Install your fire with an ECO flue kit.

The ECO flue kit is designed for installation into a home that has a ceiling cavity with unrestricted air supply as is the case with conventional homes.

In this situation, the ECO flue kit draws its ventilation air from the ceiling cavity.

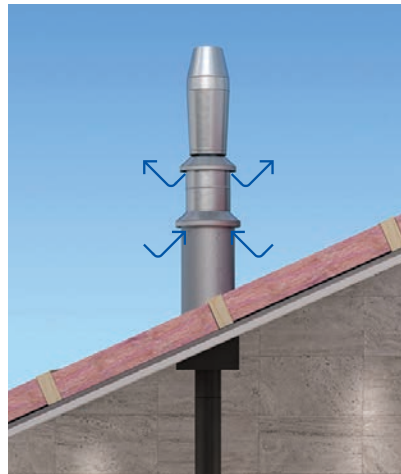

Sloping ceiling

Install your fire with an ECO flue kit and the ECO option kit.

In this situation, the ECO option kit is added to the ECO flue kit so the ventilation air can be drawn into the flue liners from above the roofline (outside the home).

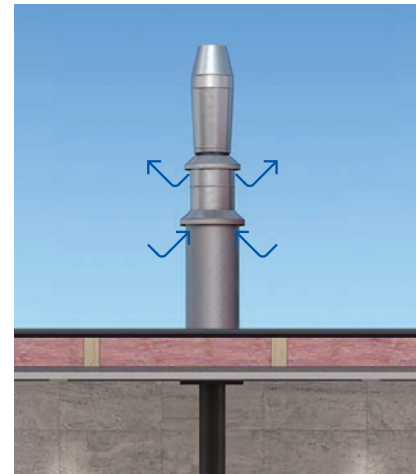

Flat ceiling with no cavity

Install your fire with an ECO flue kit and the ECO option kit unless a vented ceiling cavity with unrestricted air supply exists.

In this situation, the ECO option kit is added to the ECO flue kit so the ventilation air can be drawn into the flue liners from above the roofline (outside the home).

* Lab testing was undertaken by an independent International Accredited New Zealand (IANZ) testing facility.

How a Metro ECO flue system works

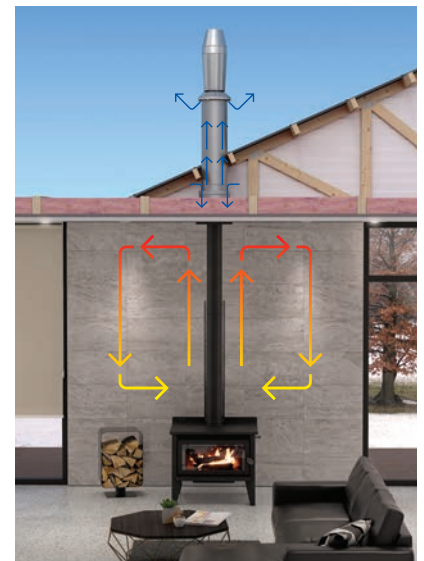
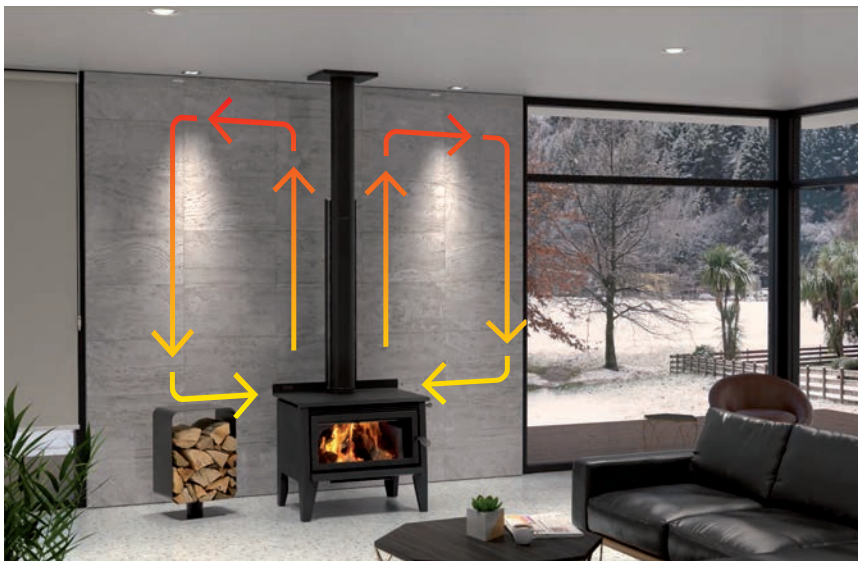

Heats your home faster and uses less firewood

An ECO flue kit is ventilated by drawing air into the flue liners from the homes ceiling cavity or from outside the home via the ECO option kit. This allows the heat generated by your fire to remain inside the home. Once the home is heated to your desired temperature the fire can be turned to a lower setting consuming less firewood, saving you money. Another performance benefit is the enhanced draw of the ECO cowl. The rocket shaped ECO cowl creates an upward vortex inducing updraft to the flue gases which increases the draw within the flue pipe improving the performance and heat output of your fire. Wind noise is also vastly reduced as the ECO flue liners are 'sealed' at ceiling level.

How a Standard flue system works

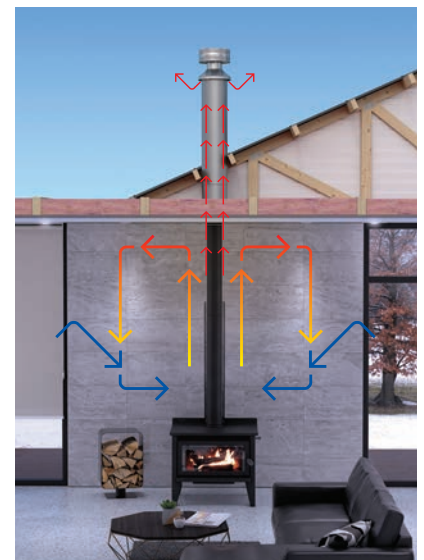
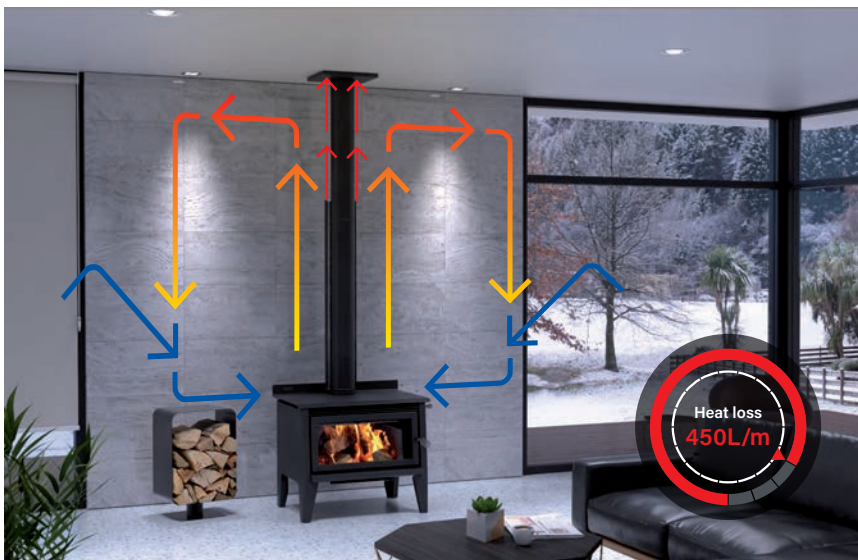

Heats your home slower and uses more firewood

A Standard flue kit is ventilated by drawing air into the flue liners from the room being heated by your fire. This lost warm air is then replaced by cooler air drawn into the room from other parts of the home at the same rate, creating a constant incoming draught. This requires the fire to be operated at a higher burn rate to heat the incoming cold air. Standard flue kits are not only less efficient, but they will heat your home slower using more firewood costing you both heat and money. As Standard flue liners are open from inside the home to the outside environment, you may also notice wind and other external noise inside the home on a windy day.

ECO flue kit components

ECO flue kit

Suitable for freestanding wood fires installed into a home with a vented ceiling cavity.

Item	Description
A	Stainless steel weather butterfly
B	Stainless steel ECO Cowl top
C	420x240mm diameter stainless steel ECO Cowl housing
D	480mm long stainless steel flue pipe extension with flashing cone
E	1200x150mm diameter stainless steel flue pipe
F	1200x250mm diameter galvanised outer casing with 750mm long slip section
G	800x200mm diameter galvanised inner casing
H	Galvanised mounting plate with brackets and 300x300mm diameter casing attached
I	Insulation gasket
J	Clip-on ceiling plate (black)
K	1200x150mm diameter stainless steel flue pipe (metallic black) (x2)
+	1 x bag of assembly bolts

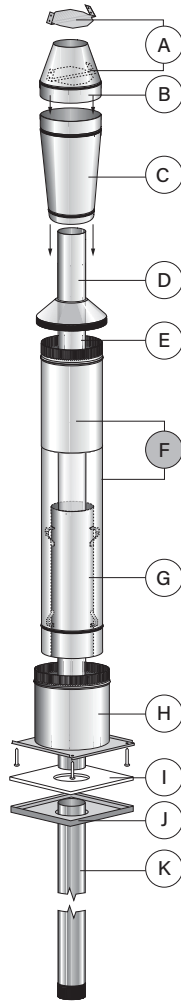

ECO option kit

An additional kit installed with the ECO flue kit for homes that don't have a vented ceiling cavity or homes that feature a sloping ceiling.

Item	Description
L	External intake flashing cone
M	780x300mm diameter galvanised outer casing
N	Dropbox infill panel
O	Dropbox edge covers
P	Ceiling plate mounted heat shield

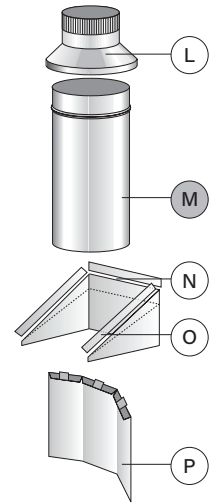

ECO extension kit

Suitable for extending all Metro flue systems within the roof space and outside the home.

Item	Description
E	1200x150mm diameter stainless steel flue pipe
F	1200x250mm diameter galvanised outer casing
G	1200x200mm diameter galvanised inner casing

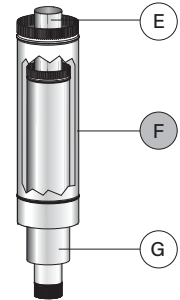

Galvanised or stainless steel outer casing option

Single storey installation

Shown (right) are the most common installation methods for installing the Metro ECO flue kit into a single storey home.

To ensure a safe and compliant installation, this flue system must be installed as detailed by either a registered installer, or someone competent in the installation of solid fuel appliances.

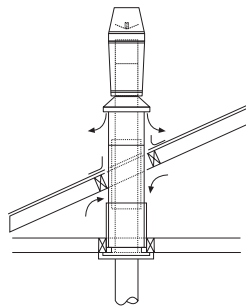

Flat ceiling/cavity

Requires the ECO flue kit as air is drawn into the flue system directly from the homes vented ceiling cavity.

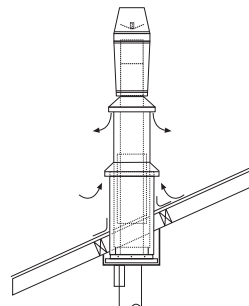

Sloping ceiling

Requires the ECO flue kit and ECO option kit for air to be drawn into the flue system from outside the home.

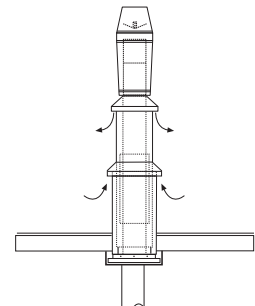

Flat ceiling/roof

Requires the ECO flue kit and ECO option kit as per sloping ceiling unless a vented ceiling cavity exists.

ECO insert flue kit

Suitable for the Smart and Trend Inserts when installed into a masonry chimney.

Ultra insert flue kit

Required with the Ultra Insert when installed into a masonry chimney.

Item	Description
A	Stainless steel weather butterfly
B	Stainless steel ECO Cowl top
C	420x240mm diameter stainless steel ECO Cowl housing
D	480mm long stainless steel flue pipe extension with flashing cone
E	(ECO Insert kit only) 1200x150mm diameter stainless steel flue pipe (x3)
E	(Ultra Insert kit only) 1200x150mm diameter stainless steel flue pipe (x2)
F	600x250mm diameter galvanised outer casing
G	(Ultra Insert kit only) 1300x150mm diameter stainless steel flue pipe and liner

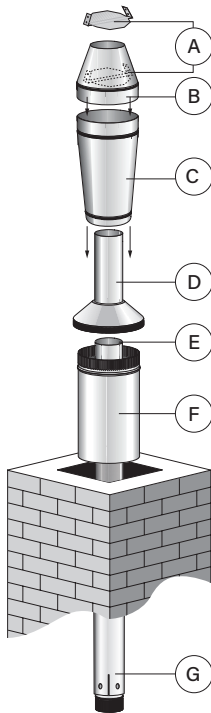

ECO built-in flue kit

Required with all Metro Built-In fires and Metro Insert fires with a Vented Zero Clearance Cabinet (VZCC) when installed into a timber framed cavity (false chimney).

The ECO built-in flue kit comprises of 3x ECO extension kits and an ECO Cowl.

Suitable for the following models:

- Smart Insert models + Smart VZCC
- Trend Insert + Trend VZCC
- Ultra Insert + Ultra VZCC
- Mega Smart Built-In

Item	Description
A	Stainless steel weather butterfly
B	Stainless steel ECO Cowl top
C	420x240mm diameter stainless steel ECO Cowl housing
D	480mm long stainless steel flue pipe extension with flashing cone
E	1200x150mm diameter stainless steel flue pipe (x3)
F	1200x250mm diameter galvanised outer casing (x3)
G	1200x200mm diameter galvanised inner casing (x3)

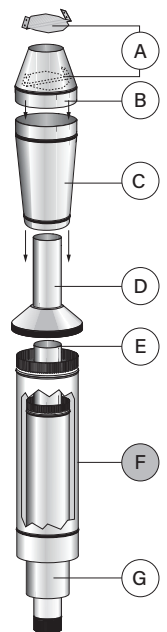

Two storey installation

Shown (right) are the most common installation methods for installing the Metro ECO flue kit into a two storey home.

To ensure safe and compliant installation, this flue system must be installed as detailed by either a registered installer, or someone competent in the installation of solid fuel appliances.

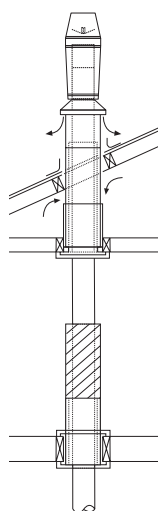

2nd floor exposed flue pipe

Requires the ECO flue kit with additional lengths of 150mm flue pipe.

Additional components are also required for this type of installation in accordance with AS/NZS 2918.*

- A floor penetration kit
- 1 x 1200mm long mesh/screen

* Not supplied by Metro Fires

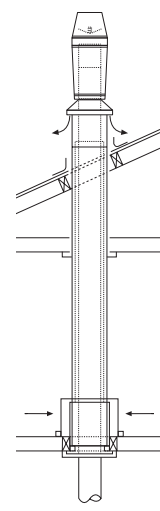

2nd floor enclosed flue pipe

Requires the ECO flue kit with additional lengths of 150mm flue pipe.

Additional components are also required for this type of installation in accordance with AS/NZS 2918.*

- 200/250mm inner/outer combination liners
- 2nd floor vent cover and additional ceiling plate with a 250mm diameter hole

* Not supplied by Metro Fires

Wall installation floor protectors

Pioneer floor protectors offer a ready-made solution in a range of styles and sizes that can be laid directly over any existing flooring substrate (carpet, vinyl, timber etc) for quick and easy installation.

All Metro freestanding fires only require an ash hearth floor protector to comply with the minimum floor protector requirements of the AS/NZS 2918 Standard.

Match your Metro fire with a suitable wall floor protector in the table opposite.

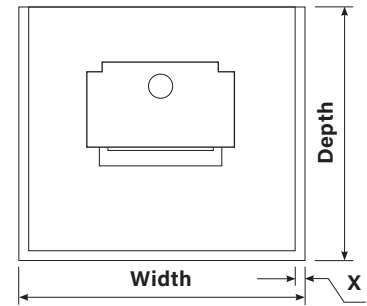

Alloy trim floor protectors



- Anodised black extruded aluminium trim and black tiles
- Tapered front corners
- 30mm thickness
- Available in 4 wall sizes

Slimline floor protectors



- Lightweight aluminium sheet in black powder coat finish
- Soft radiused front edge
- 3mm low profile thickness
- Available in 2 wall sizes

Pine trim floor protectors













- Pine timber trim in a range of tile options/colours
- Squared corners
- Trim finished with natural stain, waxed and polished
- 25mm thickness
- Available in 2 wall sizes

Rimu trim floor protectors



- Rimu timber trim in a range of tile options
- Tapered front corners
- Trim finished with natural stain, waxed and polished
- 40mm thickness
- Available in 2 wall sizes

	Alloy Tiny	Alloy Small	Alloy Medium	Alloy Deep	Slimline Small	Slimline Medium	Pine Medium	Pine Deep	Rimu Medium	Rimu Deep
										
Width	650	855	1042	1042	855	1042	955	955	980	980
Depth	830	840	1015	1148	840	1015	935	1085	945	1100
X Dimension (trim)	-	-	-	-	-	-	23	23	35	35

■ Clean air models

Tiny Ped	●	●	●	●	●	●	●	●	●	●
Tiny Rad	●	●	●	●	●	●	●	●	●	●
Tiny Rad Woody	●	●	●	●	●	●	●	●	●	●
Wee Rad - Base			●	●		●	●	●	●	●
Wee Rad - Leg		●	●	●	●	●	●	●	●	●
Wee Rad - Woody			●	●		●	●	●	●	●
Wee Ped		●	●	●	●	●	●	●	●	●
Wee Curve DV			●	●		●	●	●	●	●
Rad Plus			●	●		●	●	●	●	●
Ambie One		●	●	●	●	●	●	●	●	●
Ambie Plus			●	●		●	●			●
Xtreme Rad - Base & Leg			●	●		●	●	●	●	●
Xtreme Rad - Woody			●	●		●	●	●	●	●
Xtreme Ped			●	●		●	●	●	●	●
Mega Rad			●	●		●				

■ Ultra low emission models

Ultra Tiny Rad			●	●		●	●	●	●	●
Ultra Wee Rad			●	●		●	●	●	●	●
Ultra Xtreme Rad			●	●		●	●	●	●	●

■ LTD rural models

LTD Wee Rad - Base		●	●	●	●	●	●	●	●	●
LTD Wee Rad - Leg		●	●	●	●	●	●	●	●	●
LTD Wee Rad - Woody			●	●		●	●	●	●	●
LTD Rad Plus			●	●		●	●	●	●	●
LTD Xtreme Rad - Base & Leg			●	●		●	●	●	●	●
LTD Xtreme Rad - Woody			●	●		●	●	●	●	●
LTD Mega Rad			●	●		●				

Dimensions shown are nominal only and are in millimetres (mm). All suitable floor protector indications in the table above include a 10mm minimum skirting board allowance. When calculating the floor protector your heating appliance requires, trim measurement 'X' must be deducted from your calculations for any timber trim floor protector. The ash hearth floor protector is specified as the 'non combustible' area of the floor protector.

Corner installation floor protectors

Pioneer floor protectors offer a ready-made solution in a range of styles and sizes that can be laid directly over any existing flooring substrate (carpet, vinyl, timber etc) for quick and easy installation.

All Metro freestanding fires only require an ash hearth floor protector to comply with the minimum floor protector requirements of the AS/NZS 2918 Standard.

Match your Metro fire with a suitable corner floor protector in the table opposite.

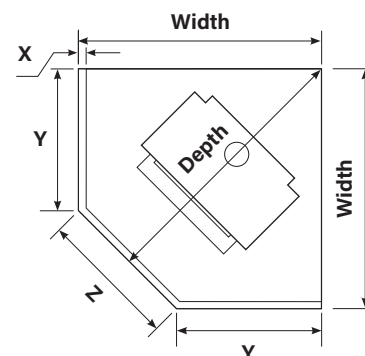

Alloy trim floor protectors



- Anodised black extruded aluminium trim and black tile
- 30mm thickness
- Available in 3 corner sizes

Slimline floor protectors



- Lightweight aluminium sheet in black powder coat finish
- 3mm low profile thickness
- Available in 2 corner sizes

Pine trim floor protectors



- Pine timber trim in a range of tile options/colours
- Trim finished with natural stain, waxed and polished
- 25mm thickness
- Available in 2 corner sizes

Rimu trim floor protectors



- Rimu timber trim in a range of tile options/colours
- Trim finished with natural stain, waxed and polished
- 40mm thickness
- Available in 3 corner sizes

	Alloy 1000	Alloy 1150	Alloy 1300	Slimline 1000	Slimline 1150	Pine 1000	Pine 1150	Rimu 1000	Rimu 1150	Rimu 1300
Width	1000	1150	1300	1000	1150	1000	1150	1000	1150	1300
Depth	1180	1310	1493	1180	1310	1180	1310	1180	1310	1525
X Dimension (trim)	-	-	-	-	-	23	23	35	35	35
Y Dimension	670	700	814	670	700	670	700	670	700	863
Z Dimension	465	640	689	465	640	465	640	465	640	619

■ Clean air approved models

Tiny Ped	●	●	●	●	●	●	●	●	●	●
Tiny Rad	●	●	●	●	●		●		●	●
Tiny Rad Woody	●	●	●	●	●	●	●	●	●	●
Wee Rad - Base		●	●		●		●		●	●
Wee Rad - Leg	● ¹	●	●	● ¹	●		●		●	●
Wee Rad - Woody		●	●		●		●			●
Wee Ped	● ²	●	●	● ²	●		●		●	●
Wee Curve DV	●	●	●	●	●		●		●	●
Rad Plus	● ¹	●	●	● ¹	●	● ¹	●	● ¹	●	●
Ambie One	●	●	●	●	●	●	●	●	●	●
Ambie Plus			●							●
Xtreme Rad - Base & Leg		●	●		●		●		●	●
Xtreme Rad - Woody		●	●		●					●
Xtreme Ped		●	●		●		●		●	●
Mega Rad			●							●

■ Ultra low emission models

Ultra Tiny Rad	● ¹	●	●	● ¹	●		●		●	●
Ultra Wee Rad		●	●		●		●		●	●
Ultra Xtreme Rad		●	●		●		●		●	●

■ LTD rural models (2Ha+)

LTD Wee Rad - Base		●	●		●		●		●	●
LTD Wee Rad - Leg	●	●	●	●	●		●		●	●
LTD Wee Rad - Woody		●	●		●		●			●
LTD Rad Plus	● ¹	●	●	● ¹	●	● ¹	●	● ¹	●	●
LTD Xtreme Rad - Base & Leg		●	●		●		●			●
LTD Xtreme Rad - Woody		●	●		●					●
LTD Mega Rad			●							●

Dimensions shown are nominal only and are in millimetres (mm). All suitable floor protector indications in the table above include a 10mm minimum skirting board allowance.

When calculating the floor protector your heating appliance requires, trim measurement 'X' must be deducted from your calculations for any timber trim floor protector. The ash hearth floor protector is specified as the 'non combustible' area of the floor protector.

1 This model must have the Pioneer corner wing shields fitted to be able to be installed onto this size floor protector.

2 This model must have the Pioneer flue shield side extensions fitted to be able to be installed onto this size floor protector.

Heat transfer



**Warmest air
rises to ceiling
30-35°C**

**Comfort level
22-24°C**

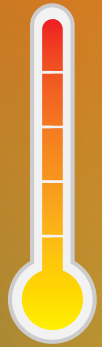

Create a warm, dry and healthy home

A wood fire can generate much more heat than is needed for just one room, but unless your home is open-plan the excess heat may not easily reach other parts of your home.

A Metro heat transfer system perfectly partners with your fire to create a dry, healthy environment and reduce condensation and dampness in your home. Excess warm air from the living space is distributed to other rooms via an insulated ducting system. This warm air then recirculates back towards the living space to keep a continual cycle of warm air movement throughout your home during winter.

Simply set the preferred temperature for your living room on the thermostat, and when your living room exceeds this preset temperature, the heat transfer system will automatically start, and distribute the excess heat to the other rooms in your home.

Metro heat transfer systems feature insulated ducting to achieve maximum heat retention with minimal air transfer noise. An additional room outlet is also available to extend the 3 room system further.

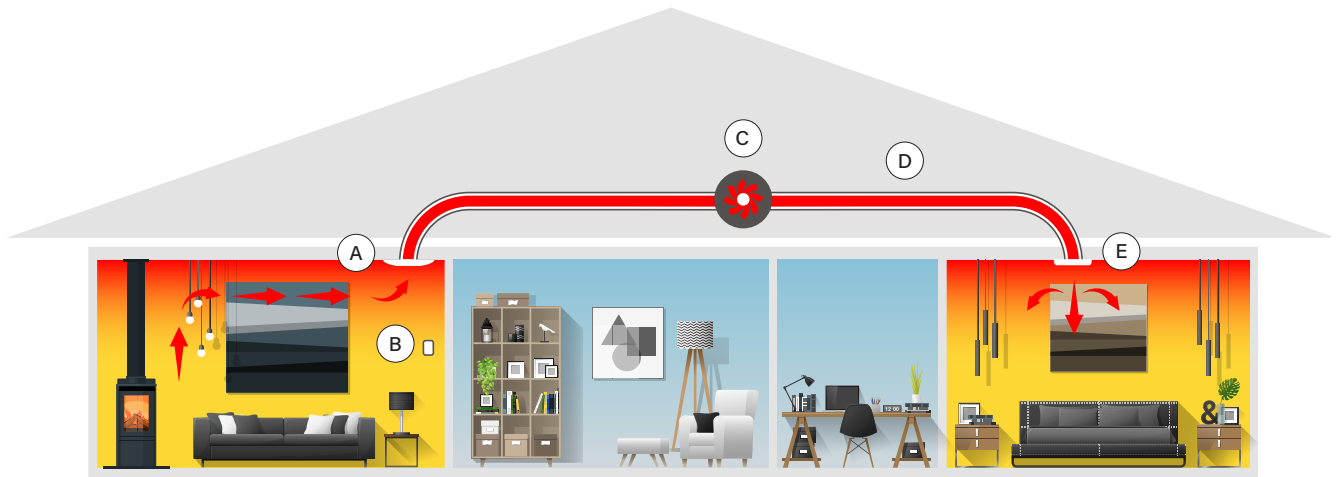

1 room heat transfer system

1 room system is ideal for smaller homes or if you are only requiring one additional room to be heated. The 1 room system comes with an inline fan capable of moving 320m³ of warm air per hour.

Item	Description	Item	Description
A	150mm diameter intake	D	3m length of 150mm diameter insulated duct (x2)
B	Thermostat	E	150mm diameter adjustable cone outlet diffuser
C	150mm diameter inline fan	F	Ducting tape (x2)

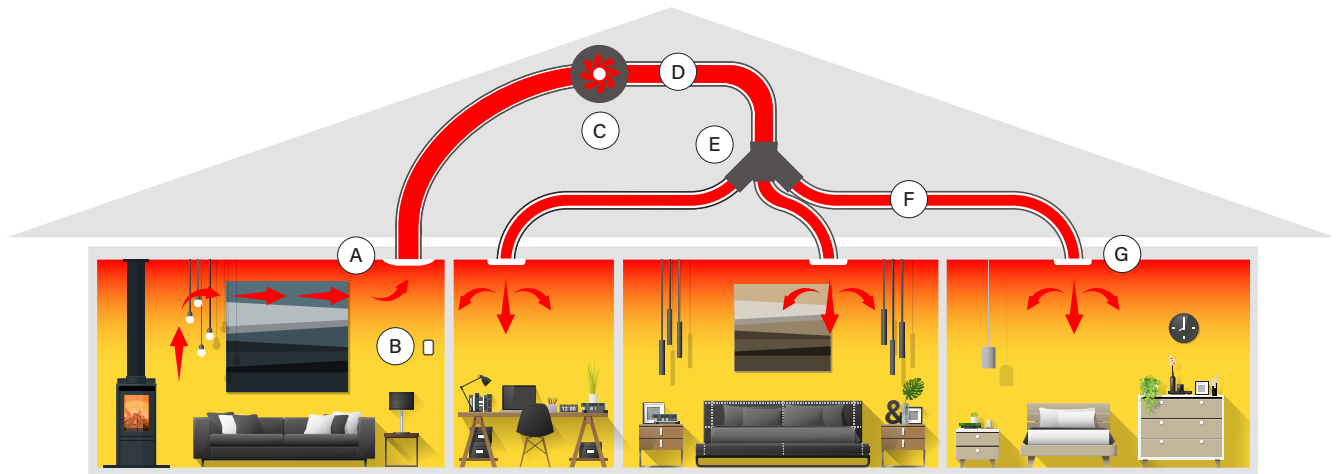

3 room heat transfer system

The 3 room system is designed to distribute an even heat throughout your home. Featuring an LCD touch panel controller and 3 speed mixed-flow fan with a maximum airflow of 910m³ of warm air per hour.

Item	Description	Item	Description
A	200mm diameter intake	E	1 x 3 way splitter
B	Digital LCD thermostat / 3 speed fan controller	F	3m length of 150mm diameter insulated duct (x3)
C	200mm diameter 3 speed fan module	G	150mm diameter adjustable cone outlet diffuser (x3)
D	3m length of 200mm diameter insulated acoustic duct (x2)	H	Ducting tape (x4)

Insert and Built-in specifications

All Metro Insert and Built-In models are tested to comply with AS/NZS 2918 incorporating Appendix 'E' when installed in accordance with the manufacturers Installation and Operation manuals and the applicable Vented Zero Clearance Cabinet installation manuals.

Installation of a Metro Insert model into a Vented Zero Clearance Cabinet (VZCC) elevates the firebox and fascia by 45mm. To conceal this space you can construct a suitable floor protector or fit a fascia base rail. Fascia base rails are available for the Smart Insert and Ultra Insert models only.

Wetback capable models

The following Metro models can also be fitted with a wetback:

Smart Insert models (Smart wetback)

Fits to the left or right hand side of the firebox externally.

Trend Insert (3kW or 4kW wetback)*

Fits to the left or right hand side of the firebox internally.

Mega Smart Built-In (Mega Smart wetback)

Fits to the left or right hand side of the firebox externally.

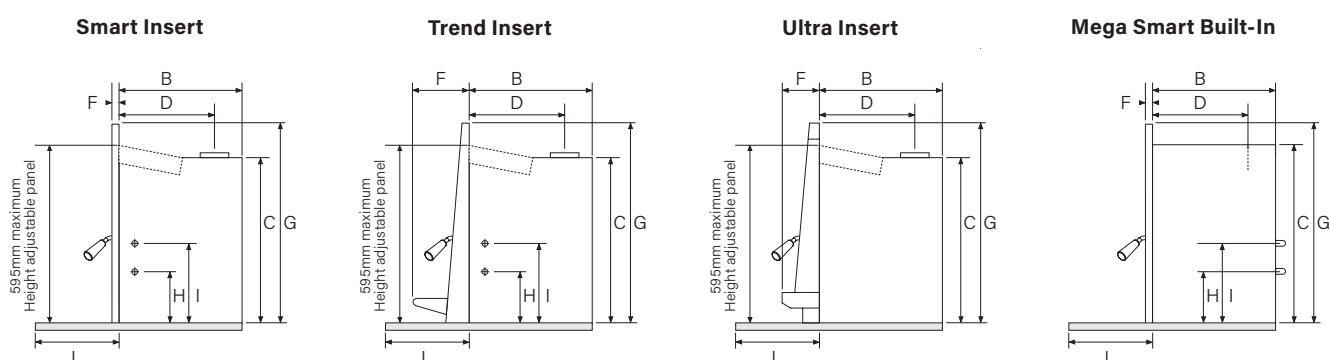

	FIREBOX WIDTH	FIREBOX DEPTH	FIREBOX HEIGHT	FLUE CENTRE	FASCIA WIDTH	FASCIA DEPTH	FASCIA HEIGHT	WETBACK INLET	WETBACK OUTLET	MANTEL CLEARANCE
	A	B	C	D	E	F	G	H	I	J
Clean air approved models										
Smart Insert	560	495	550	405	890	30	672	130	325	475
Trend Insert	560	500	550	405	810	185	650	170	360	340
Smart Built-In	693 ¹	566 ¹	695 ¹	405	890	30	672	175	370	460
Trend Built-In	693 ¹	625 ¹	695 ¹	405	810	185	650	215	405	340
Mega Smart Built-In	860	631	814	445	1057	30	822	212	402	500
Ultra low emission models										
Ultra Insert	580	530	550	405	810	120	654	-	-	500
Ultra Built-In	690 ¹	623 ¹	704 ¹	405	810	120	654	-	-	450
LTD rural models (2Ha+)										
LTD Smart Insert	560	495	550	405	890	30	672	130	325	475
LTD Smart Built-In	693 ¹	566 ¹	695 ¹	405	890	30	672	175	370	460

* The Trend model can only be fitted with a wetback on properties with a land area of 2Ha or greater.

Please note: All measurements detailed above are in millimetres (mm). Insert model measurements exclude the 13mm insulating blanket.

(1) These dimensions are for the Vented Zero Clearance Cabinet and include the spacer blocks fitted. Flue spigot liner assembly is not included in the dimensions.

Floor protector (hearth) requirements

The floor protector must project from behind the fascia the distance specified in the tables below and must extend a minimum of 200mm from each side of the firebox door opening. The minimum projection is the distance from the front of the wall lining (behind the fascia) to the front non combustible point of the floor protector.

If the Insert model floor protector is installed flush with the surrounding floor level (0mm), it must project the minimum distance detailed in the table below. The table of projections listed for heights of 0mm to 50mm can be achieved by the thickness of the floor protector, elevating the Insert model or a combination of both.

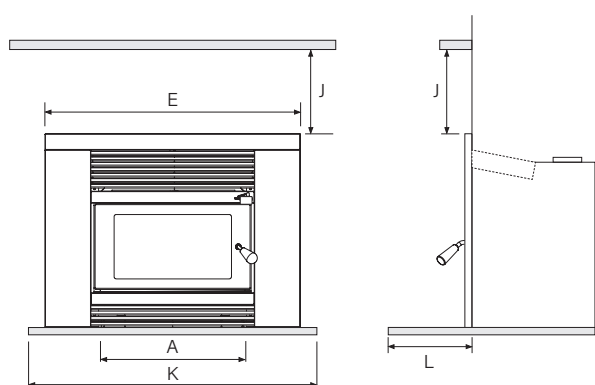

Floor protector (hearth) type

The type of floor protector required is dependent upon the installation type and the flooring substrate in front of the fire.

Ash hearth floor protector

The recommended construction for an ash hearth floor protector is tiles on 6mm thick non-combustible board or any non-combustible material fixed directly to a combustible floor is also acceptable.

Insulated hearth floor protector

The recommended construction for an insulated hearth is tiles on 26mm thick Eterpan LD board or equivalent.

Mantel clearance

A timber or combustible mantel above the fireplace opening should be a minimum distance above the top of the Metro's fascia as detailed in the table (J). If the clearance is less than the minimum specified, a heat shield will be required under the mantel using the relevant detail in AS/NZS 2918.

Floor protector (hearth) type	MINIMUM HEARTH WIDTH	MINIMUM HEARTH PROJECTION	INSERT INSTALLATION (ALL FLOOR TYPES)	BUILT-IN INSTALLATION (COMBUSTIBLE FLOOR)	BUILT-IN INSTALLATION (NON COMBUSTIBLE FLOOR)
	K	L			
Smart Insert	890	312*	Insulated hearth		
Trend Insert	825	300	Ash hearth		
Ultra Insert	825	300*	Insulated hearth		
LTD Smart Insert	890	312*	Insulated hearth		
Smart Built-In	890	460		Insulated hearth	Ash hearth
Trend Built-In	825	300		Insulated hearth	Ash hearth
Mega Smart Built-In	1057	505		Insulated hearth	Ash hearth
Ultra Built-In	825	440		Insulated hearth	Ash hearth
LTD Smart Built-In	890	460		Insulated hearth	Ash hearth

* If the Insert model floor protector is installed flush with the surrounding floor level (0mm), it must project the minimum distance detailed in the table below. The table of projections for heights of 0mm to 50mm can be achieved by the thickness of the floor protector, elevating the Insert model or a combination of both.

Height above floor level (mm)	0	10	15	20	25	30	35	40	41	50
Smart Insert	395	371	371	353	353	332	332	312	312	-
Ultra Insert	402	378	-	360	-	339	-	320	-	300
LTD Smart Insert	395	371	371	353	353	332	332	312	312	-

Freestanding specifications

All Metro freestanding fires have been tested and approved to AS/NZS 2918 with a ceiling height of 2.4m (+/-0.1m) with a Pioneer double flue shield fitted*. Minimum installation clearances are detailed in millimetres (mm). Refer to the Installation manual for your Metro fire for full specifications.

















All clearances are measured from the following reference points as illustrated in the diagrams opposite.

- The nearest combustible wall or surface (A, B, D, E, G, H)
- The Metro's flue centre (A, B, C, D)
- The Metro's cabinet/heatshield outermost point (E, F, G, H)
- The edge of the ash floor protectors non-combustible surface (C, F, I, J, K, L, M).



AS/NZS 2918 allows for a reduction in minimum clearances as detailed in Tables 3.1 and 3.2 of the Standard. Selected Metro models have undergone additional testing for reduced installation clearances. See the table footnotes.





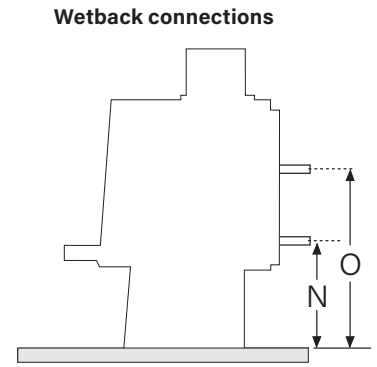
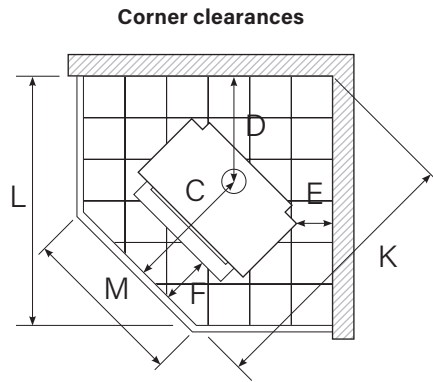
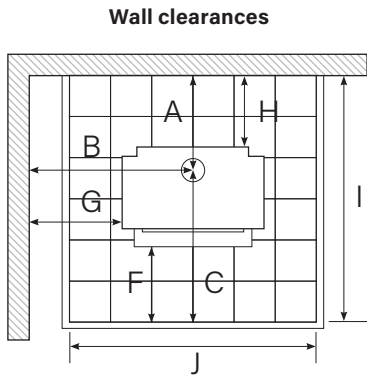



Wetback connection heights (N and O) are detailed in millimetres. Wetback centres are measured to the left of the flue centre when facing the Metro fire/wall as follows:

- Tiny Ped and Tiny Rad 92mm
- Tiny Rad Woody 184mm
- Wee Series clean air approved models 226mm
- Rad Plus and LTD Rad Plus 206mm
- All other wetback capable models 140mm

 Clean air approved models	A	B	C	D	E	F	G	H	I	J	K	L	M	N	O	WIDTH	DEPTH	HEIGHT
 Tiny Ped	211	433	580	290	25	235	185	60	791	650	990	780	250	280	470	496	492	659
 Tiny Rad	230	553	585	419	150	232	300	75	815	650	1180	910	250	280	470	505	508	667
 Tiny Rad Woody	251	568	580	382	110	232	310	100	831	650	1120	870	250	365	555	515	498	758
 Wee Rad Base	271	678	580	486	180	232	370	120	851	825	1270	1048	425	295	485	615	501	691
 Wee Rad Leg ⁽¹⁾	251	568	580	456	150	232	260	100	831	825	1225	1016	425	295	485	615	501	688
 Wee Rad Woody	271	708	580	506	200	232	400	120	851	825	1295	1066	425	365	555	615	501	758
 Wee Ped ⁽²⁾	263	651	580	473	170	230	350	110	843	825	1250	1034	425	295	485	602	503	665
 Wee Curve DV	253	555	600	405	100	214	250	100	853	825	1171	980	426	-	-	607	539	667
 Rad Plus ⁽³⁾	285	612	608	450	170	240	350	100	893	775	1244	1013	375	530	720	525	553	961
 Xtreme Rad Base	251	650	630	458	100	227	280	100	881	907	1280	1084	507	312	502	740	554	743
 Xtreme Rad Leg	251	650	630	458	100	227	280	100	881	907	1280	1084	507	312	502	740	554	743
 Xtreme Rad Woody	251	680	630	478	120	227	310	100	881	907	1306	1103	507	382	572	740	554	813
 Xtreme Ped	251	624	630	442	110	226	280	100	881	907	1260	1070	507	312	502	688	554	707
 Ambie One	250	539	589	392	100	275	250	100	839	825	1142	960	427	350	540	577	464	720
 Ambie Plus	267	686	658	462	125	275	350	100	925	906	1315	1109	506	360	550	671	550	762
 Mega Rad	285	720	728	497	100	224	300	130	1013	1006	1435	1229	606	300	490	840	659	744



Ultra low emission models		A	B	C	D	E	F	G	H	I	J	K	L	M	N	O	WIDTH	DEPTH	HEIGHT
	Ultra Tiny Rad ⁽⁴⁾	280	578	611	430	160	233	320	110	891	725	1220	977	325	-	-	515	547	688
	Ultra Wee Rad ⁽⁵⁾	270	638	581	477	170	235	330	100	851	825	1255	1040	425	-	-	615	515	707
	Ultra Xtreme Rad	277	635	632	450	100	227	280	100	909	907	1267	1075	507	-	-	710	582	722

LTD rural models (2Ha+)		A	B	C	D	E	F	G	H	I	J	K	L	M	N	O	WIDTH	DEPTH	HEIGHT
	LTD Wee Rad Base	251	658	580	486	180	232	350	100	831	825	1270	1048	425	300	490	615	501	691
	LTD Wee Rad Leg	251	548	580	426	120	232	240	100	831	825	1185	989	425	295	485	615	501	688
	LTD Wee Rad Woody	271	708	580	506	200	232	400	120	851	825	1295	1066	425	365	555	615	501	758
	LTD Rad Plus ⁽³⁾	285	612	608	450	170	240	350	100	893	775	1244	1013	375	530	720	525	553	961
	LTD Xtreme Rad Base	251	650	630	458	100	227	280	100	881	907	1280	1084	507	350	540	740	554	743
	LTD Xtreme Rad Leg	251	650	630	458	100	227	280	100	881	907	1280	1084	507	350	540	740	554	743
	LTD Xtreme Rad Woody	251	680	630	478	120	227	310	100	881	907	1306	1103	507	420	610	740	554	813
	LTD Mega Rad	285	720	728	497	100	224	300	130	1013	1006	1435	1229	606	300	490	840	659	744

- (1) Wee Rad (Leg) corner clearance (E) can be reduced to 120mm with Corner Wing Shields fitted. This also reduces clearances (D) to 426mm, (K) to 1185mm and (L) to 987mm.
- (2) Wee Ped corner clearance (E) can be reduced to 115mm if side extensions are fitted to the flue shield. This also reduces clearances (D) to 418mm, (K) to 1170mm and (L) to 978mm.
- (3) Rad Plus models corner clearance (E) can be reduced to 100mm with Corner Wing Shields fitted. This also reduces clearances (D) to 380mm, (K) to 1145mm and (L) to 942mm.
- (4) Ultra Tiny Rad corner clearance (E) can be reduced to 125mm with Corner Wing Shields fitted. This also reduces clearances (D) to 396mm, (K) to 1171mm and (L) to 943mm.
- (5) Ultra Wee Rad corner clearance (E) can be reduced to 136mm with Corner Wing Shields fitted. This also reduces clearances (D) to 442mm, (K) to 1207mm and (L) to 1005mm.

* Rad Plus and LTD Rad Plus models must be installed with the Pioneer 900mm double flue shield.

All specifications are correct and current at time of printing, but may alter and those detailed should be used as a guide only.

Specifications are subject to change without notification. If in doubt please consult your local Metro Fires agency or visit metrofires.co.nz.

PIONEER
MANUFACTURING LIMITED

metrofires

ULTRA FIRES

outdoor

Starship
Campaign Supporter



www.metrofires.co.nz
info@metrofires.co.nz
facebook.com/metrofires